

PRD 



Inoxydable
Stainless



SP738 REVÊTEMENT PROTECTEUR POUR ACIER INOXYDABLE

Donne un maximum de résistance à la corrosion pour les surfaces en métal, en chrome, en céramique et en cuivre. Formulé à base de 100% de pigment inox type 316L. Sèche rapidement pour produire un fini satin, sèche en quelques heures et durcit pour donner une résistance maximale en quelques jours.

- Agréé par l'USDA
 - Contient des particules d'acier inoxydable.
 - À utiliser pour camoufler l'altération des couleurs dans les parties soudées.
 - Muni d'une soupape DanVern standard.
- Utilisez SP738 sur les tuyaux d'évacuation et de vapeur, les silencieux, les radiateurs, l'équipement de production, les moteurs, les chaudières, les accessoires de plomberie, l'équipement de traitement chimique.
- Cannette de 16oz (poids net de 12oz) caisse de 12



SP739 COMPOSÉ DE GALVANISATION À FROID DU ZINC

Ce revêtement empêche la corrosion des métaux ferreux. Permet des retouches pour la réfection des subjectiles galvanisés. Produit un revêtement sec ayant la FINITION BRILANTE de la galvanisation à chaud. Épaisseur recommandée de la pellicule sèche: 1.5 à 3 mils.

- Conforme aux règlements sur les COV.
 - Sèche au toucher en 30 minutes.
 - Nouvelle couche possible après deux à seize heures, ou après 36 heures.
- Utilisez SP739 dans les usines de transformation alimentaire, les usines automobile, les raffineries, les centrales nucléaires, les centrales électriques et les tours de transmission, et sur les clôtures, les gouttières, les ponts, l'acier structural, le fer forgé, l'équipement agricole, les surfaces galvanisées endommagées, pour l'entretien routier et les applications marine.

Cannette de 16 oz (poids net 16 oz) caisse de 12

SP740 COMPOSÉ DE GALVANISATION À FROID À FORTE TENEUR EN ZINC

Un revêtement à haut extrait sec, à séchage facile, qui offre une protection maximale à l'acier exposé à un milieu très corrosif. Ce revêtement époxydique très performant assure la fusion du zinc au subjectile métallique afin de le protéger contre la corrosion.

- Au moins aussi efficace que la galvanisation à chaud.
- Excellente protection contre l'affaïssement.
- Très résistant à la corrosion par le sel et l'eau.
- Conforme ou supérieur aux exigences de rendement de MIL-P-26915A, MIL-T-26433, MIL-P-21035, MIL-P-46105 et des tests Preece.
- Poussière de zinc pure à 97%.
- Peut être recouvert d'une couche d'apprêt ou de finition métallique ordinaire.
- Agréé par l'USDA.

Utilisez le SP740 sur les surface exposées à des conditions difficiles de corrosion et de rouille, comme les clôtures, les gouttières, les ponts, l'acier structural, le fer forgé, l'équipement agricole. Parfait comme produit d'entretien à pulvériser sur les routes, les usines de transformation alimentaire, les centrales électriques, les raffineries ou les surfaces galvanisées endommagées.

- SP740 Cannette 16 oz / caisse: 12
- SP74001 Boîte d'un gallon / caisse: 4
- SP74000 Boîte d'une pinte / caisse: 6



FASCO® PEINTURES ÉMAIL ET APPRÊTS À PONCER

Peinture en aérosol de qualité supérieure à un prix économique. Fasco® fournit une finition résistante qui est durable et inhibe la rouille. Disponible dans une gamme complète de couleurs, certaines étant disponibles en finition mate. Cache bien, sèche rapidement et résiste à l'écaillage et au pelage. Pour une protection maximale, les surfaces métalliques rouillées doivent être brossées et apprêtées avec nos apprêts Fasco®.

Cannette de 340g caisse de 6

COULEURS DISPONIBLES / AVAILABLE COLORS

F1004 Noir lustré Gloss Black	F1024 Blanc lustré Gloss White	F1005 Noir mat Mat Black	F1003 Bleu foncé Dark Blue	F1002 Bleu moyen Medium Blue	F1006 Rouge cerise Cherry Red
F1007 Rouge brique Brick Red	F1018 Vert forêt Forest Green	F1023 Gris foncé Dark Gray	F1021 Gris pâle Light Gray	F1013 Jaune pâle Pale Yellow	F1010 Orange

APPRÊTS / PRIMERS

F1031 Gris pâle	F1032 Rouge oxyde

RENSEIGNEMENTS GÉNÉRAUX / GENERAL INFORMATION

Siège social / Head Office – Québec
6500, Zéphirin-Paquet, Québec QC G2C 0M3
Téléphone / Phone: (418) 872-6018
Sans frais / Toll Free : 1-800-463-5259
Télécopieur / Fax: (418) 872-6583
Télécopieur sans frais / Fax Free : 1-800-872-6018
Courriel / Email: prdist@prdistribution.ca
www.prdistribution.ca

Succursale / Branch - Chicoutimi
1100, Manic, Chicoutimi QC G7K 1A2
Téléphone / Phone: (418) 545-1100
Télécopieur / Fax: (418) 545-1104

COMMENT COMMANDER ? / HOW TO ORDER ?

DE VOTRE REPRÉSENTANT PRD

Les représentants de PR Distribution visitent de nombreuses régions, mais la fréquence de leurs visites peut varier. N'attendez donc pas la visite de votre vendeur pour commander. Placez vos commandes par téléphone, télécopieur ou par courriel. Votre vendeur sera crédité pour la commande.

POUR COMMANDER

Veillez utiliser les NUMÉRO de stock et la DIMENSION des articles commandés. Veuillez de plus, indiquer clairement le nom, l'adresse complète de facturation et de livraison (si différente) ainsi, que le numéro de téléphone de votre compagnie. Pour nos nouveaux clients, veuillez compléter le formulaire d'ouverture de compte, ci-joint au présent document.

FACTURATION MINIMALE

Le minimum d'une facture unique ou de frais de facturation au Canada est de 10\$.

CONDITIONS DE PAIEMENT

Pour les clients avec un compte établi, les termes sont de 30 jours net. Autrement, le paiement par cartes de crédit majeures, doit être fait avec la commande. Aucun envoi contre remboursement.

Nous acceptons les cartes de crédit tel que ; VISA, MasterCard et American Express. Interac est accepté au comptoir seulement.

Le taux d'intérêt est 2% par mois (24% par an) sur tout compte en souffrance. Les intérêts seront ajoutés à la balance des paiements.

EXPÉDITION

À moins d'avis contraire de votre part, PR Distribution expédiera votre commande par le transporteur le meilleur et le plus économique. Toutes les livraisons postales sont assurées et les frais de livraison comprennent les (charges) d'assurance.

Les commandes sont expédiées par l'une des façons suivantes : port payé, port dû ou port payé et chargé, ou selon l'entente pré-établie.

RÉCLAMATIONS

Toutes les livraisons de PR Distribution sont expédiées en excellente condition et sont acceptées comme telles par le transporteur. Si des pertes ou dommages sont constatés, prière de noter sur le bordereau de livraison du transporteur et de présenter immédiatement une réclamation à la compagnie de transport.

Si les dommages sont imputables à une erreur de notre part, nous réexpédierons la commande et autoriserons un retour de marchandise. Toute marchandise retournée à cause d'une erreur de commande de votre part ne sera acceptée que dans les 60 jours après l'achat, suivant l'autorisation écrite de notre part, et sera soumise à des frais de manutention de 20% de la valeur de la commande.

RETOUR DE MARCHANDISE

En cas de retour autorisé à la demande du client, la marchandise retournée sera soumise à des frais de manutention de 20%. Toute marchandise retournée doit être non-endommagée, pouvoir être revendue, et retournée dans l'emballage original seulement. TOUT RETOUR DE MARCHANDISE DOIT ÊTRE AUTORISÉ PAR ÉCRIT PAR PR DISTRIBUTION.

COMMANDES SPÉCIALISÉES

Les commandes spécialisées ou produits modifiés spécifiquement pour vous, ne peuvent être annulées. Ceci inclut les produits fabriqués ou reçus en grande quantité, tel que mentionné à la prise de commande.

RESPONSABILITÉ

En acceptant les livraisons de PR Distribution, l'acheteur reconnaît que notre responsabilité ne dépasse pas la valeur d'achat de la marchandise expédiée.

Les applications et spécifications proviennent de sources crédibles. Cependant, PR Distribution ne peut garantir la précision des informations. PR Distribution ne peut accepter la responsabilité des erreurs, oublis ou changements, et tout ce qui s'ensuit. Nous pouvons remplacer les items seulement.

THROUGH PRD SALES REPRESENTATIVES

PR Distribution has sales representatives covering many areas. Because their call frequencies may vary, please do not wait for your salesman's call. Phone, mail or email your order to our office. Your salesman will receive credit for the order.

WHEN ORDERING

Please give stock no. and the item DIMENSION. Also supply complete firm name, complete address for delivery and invoicing, and phone number. New customers should complete the credit application form included.

FACTURATION MINIMALE

The minimum single invoice or billing charge within Canada is \$10.

PAYMENT TERMS

For customers with established accounts the terms are Net 30 days. Otherwise, payment by major credit cards (VISA, MasterCard or American Express) is due with order. No C.O.D. shipments. Interest at a rate of 2% per month (24% per year) is applicable and may be added to overdue balances.

SHIPPING

Unless you specify differently, PR Distribution will ship via the best and most economical carrier. All parcel post shipments are insured, and delivery charges included in the price. We expedite your order within our shipping conditions, pre-paid, collect or pre-paid and charge.

CLAIMS

All PR Distribution shipments leave our premises in first-class condition, and accepted as such by the carrier. If damage or loss is evident, indicate it on carrier's delivery receipt, and file claim immediately with the carrier.

If wrong or defective merchandise is received through an error of our part, we will reship and authorize a pick-up or collect return. Merchandise returned because of incorrect ordering will be accepted back only within 60 days of purchase, subject to our written autorisation, and a re-stocking charge of 20 % of order value.

RETURNS / EXCHANGES

If an authorized return is made for the convenience of the customer a 20% charge will be made for handling and re-stocking. All merchandise must be returned in new and saleable condition in the original carton. IN NO CASE WILL MERCHANDISE BE ACCEPTED BACK WITHOUT THE WRITTEN CONSENT OF PR DISTRIBUTION.

SPECIAL ORDERS

Small or big quantities of special orders or custom made products may not be cancelled.

LIABILITY

In accepting shipments from PR Distribution the purchaser agrees that our liability does not exceed the purchase value of the goods shipped.

Specifications and application information have been researched using reliable sources to obtain the most accurate listing; however, PR Distribution does not make or imply any warranty concerning the accuracy of the information. PR Distribution does not accept responsibility for errors, omissions or changes or for harm resulting there from. Warranty is limited to the replacement of product only.



INDEX

B		V	
Boulons de carrosserie / 18-8	15	Vis à 6 pans creux tête cylindrique UNC / 18-8	30-31-32
Boulons de carrosserie / HDG	51	Vis à 6 pans creux tête cylindrique UNF / 18-8	33
Boulons de précision hexagonaux UNC / 18-8	6-7-8	Vis à 6 pans creux tête fraisée UNC / 18-8	34-35
Boulons de précision hexagonaux UNC / 316	46-47	Vis à 6 pans creux tête fraisée UNF / 18-8	35
Boulons de précision hexagonaux UNC / Laiton	50	Vis à 6 pans creux tête ronde / 18-8	36
Boulons de précision hexagonaux UNF / 18-8	9-10	Vis à machine tête ovale / étoilée / 18-8	20
		Vis à machine tête pan / étoilée / 18-8	22
E		Vis à machine tête pan / fendue / 18-8	21
Écrous à créneaux dégagés / 18-8	11	Vis à machine tête plate / étoilée / 18-8	19
Écrous à oreilles / 18-8	11	Vis à machine tête plate / fendue / 18-8	17-18
Écrous auto-bloquants / 316	48	Vis à machine tête plate / fendue / Laiton	50
Écrous auto-bloquants UNC / 18-8	11	Vis à machine tête truss / étoilée / 18-8	23
Écrous auto-bloquants UNF / 18-8	11	Vis à métal auto-perçante tête hexagone / 18-8	27
Écrous borgnes / 18-8	12	Vis à métal auto-perçante tête pan / étoilée / 18-8	29
Écrous hexagonaux pour vis à machine / 18-8	12	Vis à métal auto-perçante tête plate / carrée / 18-8	28
Écrous hexagonaux / 316	48	Vis à métal auto-perçante tête plate / étoilée / 18-8	28
Écrous hexagonaux / HDG	52	Vis à métal auto-perçante tête plate / carrée / 18-8	29
Écrous hexagonaux / LAITON	50	Vis à métal tête hexagone / 18-8	27
Écrous hexagonaux UNC / 18-8	11	Vis à métal tête ovale / étoilée / 18-8	26
Écrous hexagonaux UNF / 18-8	11	Vis à métal tête pan / carrée / 18-8	25
		Vis à métal tête pan / étoilée / 18-8	25
F		Vis à métal tête plate / carrée / 18-8	24
Fausse vis tête ronde type U / 18-8	16	Vis à métal tête plate / étoilée / 18-8	24
		Vis à métal tête truss / étoilée / 18-8	26
G		Vis à patio tête bugle / carrée / 18-8	23
Goupilles cylindriques / 18-8	43	Vis de pression à 6 pans creux / conique / 18-8	39
Goupilles fendues / 18-8	45	Vis de pression à 6 pans creux / demi-téton / 18-8	40
Goupilles ressorts / 420	44	Vis de pression à 6 pans creux / cuvette / 18-8	37-38
		Vis de pression à 6 pans creux / plate / 18-8	39
R		Vis de pression à 6 pans creux / ovale / 18-8	40
Rondelles à madrier / 18-8	14	Vis de pression à tête carrée / cuvette / 18-8	41
Rondelles de blocages à dentures / 18-8	14		
Rondelles de pare-choc / 18-8	13		
Rondelles hermétiques / 302	14		
Rondelles plates / 18-8	13		
Rondelles plates / 316	49		
Rondelles plates / HDG	52		
Rondelles plates / LAITON	50		
Rondelles ressorts / 18-8	13		
Rondelles ressorts / 316	49		
T			
Tiges filletées / 316	49		
Tiges filletées UNC / 18-8	42		
Tiges filletées UNF / 18-8	42		
Tire-fonds tête hexagone / 18-8	15		
Tire-fonds tête hexagone / HDG	51		



**PAGE: (18-8) 6 à 10
(316) 46, 47
(BR) 50**



**PAGE: (18-8) 11
(316) 48
(BR) 50, (HDG)**

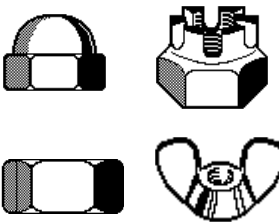

PAGE: 12, 48

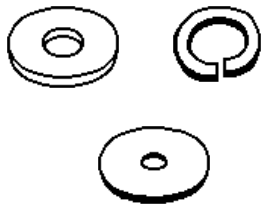

PAGE: 13, 49, (HDG) 52

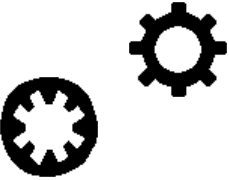

PAGE: 14

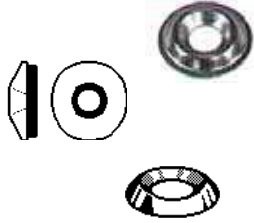

PAGE: 14

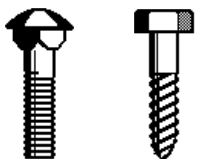

PAGE: 15, (HDG) 51

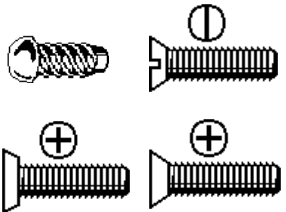

PAGE: 16 à 19

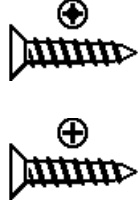

PAGE: 24

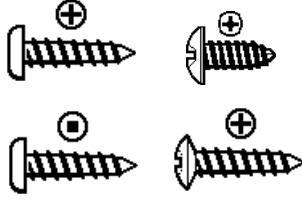

PAGE: 25, 26

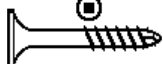

PAGE: 23

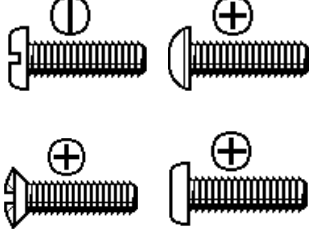

PAGE: 20 à 23

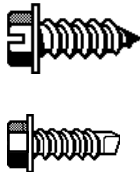

PAGE: 27

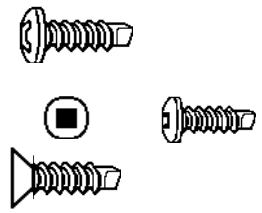

PAGE: 28, 29

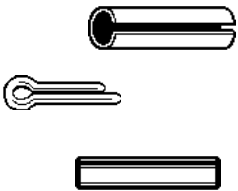

PAGE: 43, 44, 45



PAGE: 42, 49

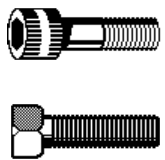

PAGE: 30 à 33, 41

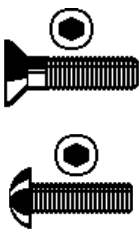

PAGE: 34 à 36

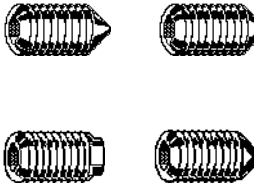

PAGE: 37 à 40

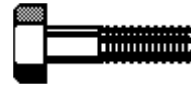
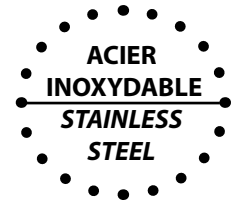

PAGE: 53

**BOULONS DE PRÉCISION HEXAGONAUX
HEXAGON CAP SCREWS**FILET GROS / COARSE THREAD **U.N.C. (U.S.S.)**
ACIER INOXYDABLE / STAINLESS STEEL **18-8 (304)****18-8**

NUMÉRO	DIMENSION			BTE	NUMÉRO	DIMENSION			BTE	NUMÉRO	DIMENSION			BTE
403-447A	4-40	x	3/4	100	400-104	10-24	x	1-1/4	100	400-128	5/16-18	x	1-1/4	50
403-449	4-40	x	1	100	400-105	10-24	x	1-1/2	100	400-129	5/16-18	x	1-1/2	50
					400-105B	10-24	x	2	100	400-130	5/16-18	x	1-3/4	50
403-452	6-32	x	1/4	100						400-131	5/16-18	x	2	50
403-453	6-32	x	5/16	100	403-473	1/4-20	x	3/8	100	400-132	5/16-18	x	2-1/4	25
403-454	6-32	x	3/8	100	400-106	1/4-20	x	1/2	100	400-133	5/16-18	x	2-1/2	25
403-455	6-32	x	1/2	100	400-107	1/4-20	x	5/8	100	400-134	5/16-18	x	2-3/4	25
403-456	6-32	x	5/8	100	400-108	1/4-20	x	3/4	100	400-135	5/16-18	x	3	25
403-457	6-32	x	3/4	100	400-109	1/4-20	x	7/8	100	403-475	5/16-18	x	3-1/4	25
403-458	6-32	x	1	100	400-110	1/4-20	x	1	100	400-136	5/16-18	x	3-1/2	10
					400-111	1/4-20	x	1-1/4	100	403-476	5/16-18	x	3-3/4	10
403-460	8-32	x	1/4	100	400-112	1/4-20	x	1-1/2	100	400-137	5/16-18	x	4	10
403-461	8-32	x	5/16	100	400-113	1/4-20	x	1-3/4	100	400-138	5/16-18	x	4-1/2	10
403-462	8-32	x	3/8	100	400-114	1/4-20	x	2	100	400-139	5/16-18	x	5	10
403-463	8-32	x	1/2	100	400-115	1/4-20	x	2-1/4	50	400-139A	5/16-18	x	5-1/2	10
403-464	8-32	x	5/8	100	400-116	1/4-20	x	2-1/2	50	400-139B	5/16-18	x	6	10
403-465	8-32	x	3/4	100	400-117	1/4-20	x	2-3/4	50	400-139E	5/16-18	x	7	10
403-466	8-32	x	7/8	100	400-118	1/4-20	x	3	25					
403-467	8-32	x	1	100	403-474	1/4-20	x	3-1/4	25	400-140	3/8-16	x	1/2	50
403-468	8-32	x	1-1/2	100	400-119	1/4-20	x	3-1/2	25	400-141	3/8-16	x	5/8	50
403-469	8-32	x	2	100	400-120	1/4-20	x	4	25	400-142	3/8-16	x	3/4	50
					400-121	1/4-20	x	4-1/2	10	403-477	3/8-16	x	7/8	50
403-470	10-24	x	1/4	100	400-122	1/4-20	x	5	10	400-143	3/8-16	x	1	50
403-471	10-24	x	3/8	100	400-122A	1/4-20	x	5-1/2	10	400-144	3/8-16	x	1-1/4	25
400-101	10-24	x	1/2	100	400-122B	1/4-20	x	6	10	400-145	3/8-16	x	1-1/2	25
403-472	10-24	x	5/8	100						400-146	3/8-16	x	1-3/4	25
400-102	10-24	x	3/4	100	400-123	5/16-18	x	1/2	100	400-147	3/8-16	x	2	25
400-103	10-24	x	1	100	400-124	5/16-18	x	5/8	100	400-148	3/8-16	x	2-1/4	25
					400-125	5/16-18	x	3/4	50	400-149	3/8-16	x	2-1/2	25
					400-126	5/16-18	x	7/8	50	400-150	3/8-16	x	2-3/4	25
					400-127	5/16-18	x	1	50					

**ÉCROUS HEXAGONE
U.N.C. / 18-8**

NUMÉRO	DIMENSION	BTE
400-272	4-40	100
400-273	6-32	100
400-274	8-32	100
400-275	10-24	100
400-240	1/4-20	100
400-242	5/16-18	100
400-244	3/8-16	50

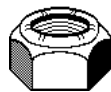
**ÉCROUS BAGUE DE NYLON
U.N.C. / 18-8**

NUMÉRO	DIMENSION	BTE
400-286	4-40	100
400-287	6-32	100
400-288	8-32	100
400-289	10-24	100
400-291	1/4-20	100
400-292	5/16-18	100
400-293	3/8-16	50

**RONDELLES PLATES
18-8**

NUMÉRO	DIMENSION	BTE
400-306	4	100
400-307	6	100
400-308	8	100
400-309	10	100
400-311	1/4	100
400-312	5/16	100
400-313	3/8	100

**RONDELLES-RESSORTS
18-8**

NUMÉRO	DIMENSION	BTE
400-326	4	100
400-327	6	100
400-328	8	100
400-329	10	100
400-330	1/4	100
400-331	5/16	100
400-332	3/8	100



BOULONS DE PRÉCISION HEXAGONAUX HEXAGON CAP SCREWS

FILET GROS / COARSE THREAD U.N.C. (U.S.S.)
ACIER INOXYDABLE / STAINLESS STEEL 18-8 (304)

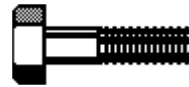

18-8

ACIER
INOXYDABLE
STAINLESS
STEEL

NUMÉRO	DIMENSION	BTE	NUMÉRO	DIMENSION	BTE	NUMÉRO	DIMENSION	BTE
400-151	3/8-16 x 3	10	403-491	1/2-13 x 1/2	25	403-502	9/16-12 x 1	25
403-478	3/8-16 x 3-1/4	10	403-492	1/2-13 x 5/8	25	403-503	9/16-12 x 1-1/2	25
400-152	3/8-16 x 3-1/2	10	400-164	1/2-13 x 3/4	25	403-503A	9/16-12 x 1-3/4	25
403-479	3/8-16 x 3-3/4	10	403-493	1/2-13 x 7/8	25	403-504	9/16-12 x 2	25
400-153	3/8-16 x 4	10	400-165	1/2-13 x 1	25	403-505	9/16-12 x 2-1/2	25
400-154	3/8-16 x 4-1/2	10	400-166	1/2-13 x 1-1/4	25	403-506	9/16-12 x 3	25
400-155	3/8-16 x 5	10	400-167	1/2-13 x 1-1/2	25	403-507	9/16-12 x 3-1/2	25
403-480	3/8-16 x 5-1/2	10	400-168	1/2-13 x 1-3/4	25	403-508	9/16-12 x 4	25
400-156	3/8-16 x 6	10	400-169	1/2-13 x 2	20			
403-481	3/8-16 x 6-1/2	1	400-170	1/2-13 x 2-1/4	20	400-182	5/8-11 x 1	25
403-482	3/8-16 x 7	1	400-171	1/2-13 x 2-1/2	20	400-183	5/8-11 x 1-1/4	25
403-483	3/8-16 x 8	1	400-172	1/2-13 x 2-3/4	20	400-184	5/8-11 x 1-1/2	25
403-484	3/8-16 x 9	1	400-173	1/2-13 x 3	10	400-185	5/8-11 x 1-3/4	20
403-485	3/8-16 x 10	1	400-173A	1/2-13 x 3-1/4	10	400-186	5/8-11 x 2	20
			400-174	1/2-13 x 3-1/2	10	400-187	5/8-11 x 2-1/4	20
403-486	7/16-14 x 3/4	25	403-494	1/2-13 x 3-3/4	10	400-188	5/8-11 x 2-1/2	20
400-157	7/16-14 x 1	25	400-175	1/2-13 x 4	10	400-189	5/8-11 x 2-3/4	20
400-158	7/16-14 x 1-1/4	25	400-176	1/2-13 x 4-1/2	10	400-190	5/8-11 x 3	10
400-159	7/16-14 x 1-1/2	25	400-177	1/2-13 x 5	10	403-509	5/8-11 x 3-1/4	10
400-160	7/16-14 x 1-3/4	25	400-178	1/2-13 x 5-1/2	10	400-191	5/8-11 x 3-1/2	10
400-161	7/16-14 x 2	20	400-179	1/2-13 x 6	5	403-510	5/8-11 x 3-3/4	10
400-161A	7/16-14 x 2-1/4	20	403-495	1/2-13 x 6-1/2	5	400-192	5/8-11 x 4	10
400-162	7/16-14 x 2-1/2	20	400-180	1/2-13 x 7	5	400-193	5/8-11 x 4-1/2	10
403-487	7/16-14 x 2-3/4	10	403-496	1/2-13 x 7-1/2	5	400-194	5/8-11 x 5	10
400-163	7/16-14 x 3	10	400-181	1/2-13 x 8	5	400-195	5/8-11 x 5-1/2	10
400-163A	7/16-14 x 3-1/2	10	403-497	1/2-13 x 8-1/2	1	400-196	5/8-11 x 6	10
403-488	7/16-14 x 4	10	403-498	1/2-13 x 9	1	403-511	5/8-11 x 6-1/2	5
403-489	7/16-14 x 4-1/2	10	403-499	1/2-13 x 10	1	400-197	5/8-11 x 7	5
403-490	7/16-14 x 5	10	403-500	1/2-13 x 11	1	403-512	5/8-11 x 7-1/2	5
			403-501	1/2-13 x 12	1	400-198	5/8-11 x 8	5
						403-513	5/8-11 x 8-1/2	1
						403-513A	5/8-11 x 9	1
						403-514	5/8-11 x 10	1



ÉCROUS HEXAGONE U.N.C. / 18-8

NUMÉRO	DIMENSION	BTE
400-244	3/8-16	50
400-246	7/16-14	50
400-248	1/2-13	25
403-576	9/16-12	25
400-250	5/8-11	25



ÉCROUS BAGUE DE NYLON U.N.C. / 18-8

NUMÉRO	DIMENSION	BTE
400-293	3/8-16	50
400-293A	7/16-14	50
400-294	1/2-13	25
400-294A	9/16-12	25
400-295	5/8-11	25



RONDELLES PLATES 18-8

NUMÉRO	DIMENSION	BTE
400-313	3/8	100
400-314	7/16	50
400-315	1/2	50
400-315A	9/16	50
400-316	5/8	25



RONDELLES-RESSORTS 18-8

NUMÉRO	DIMENSION	BTE
400-332	3/8	100
400-333	7/16	50
400-334	1/2	50
400-334A	9/16	50
400-335	5/8	25

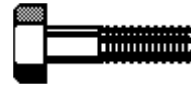
**BOULONS DE PRÉCISION HEXAGONAUX
HEXAGON CAP SCREWS**FILET GROS / COARSE THREAD **U.N.C. (U.S.S.)**
ACIER INOXYDABLE / STAINLESS STEEL **18-8 (304)****18-8**ACIER
INOXYDABLE
STAINLESS
STEEL

NUMÉRO	DIMENSION	BTE	NUMÉRO	DIMENSION	BTE	NUMÉRO	DIMENSION	BTE			
403-515	3/4-10	x 1	20	403-527	7/8-9	x 3-1/4	10	403-542	1-8	x 8	1
403-516	3/4-10	x 1-1/4	20	400-218	7/8-9	x 3-1/2	10	403-543	1-8	x 9	1
400-199	3/4-10	x 1-1/2	20	403-528	7/8-9	x 3-3/4	5	403-544	1-8	x 10	1
400-201	3/4-10	x 1-3/4	20	400-219	7/8-9	x 4	5	403-545	1-1/8-7	x 2-1/2	1
400-202	3/4-10	x 2	20	400-220	7/8-9	x 4-1/2	5	403-546	1-1/8-7	x 3	1
400-203	3/4-10	x 2-1/4	20	400-221	7/8-9	x 5	5	403-547	1-1/8-7	x 3-1/2	1
400-204	3/4-10	x 2-1/2	20	400-222	7/8-9	x 5-1/2	5	403-548	1-1/8-7	x 4	1
400-205	3/4-10	x 2-3/4	20	400-223	7/8-9	x 6	5	403-549	1-1/8-7	x 4-1/2	1
400-206	3/4-10	x 3	10	403-529	7/8-9	x 6-1/2	1	403-550	1-1/8-7	x 5	1
403-517	3/4-10	x 3-1/4	10	403-530	7/8-9	x 7	1	403-551	1-1/8-7	x 5-1/2	1
400-207	3/4-10	x 3-1/2	10	403-531	7/8-9	x 7-1/2	1	403-552	1-1/8-7	x 6	1
403-518	3/4-10	x 3-3/4	10	403-532	7/8-9	x 8	1	403-553	1-1/8-7	x 6-1/2	1
400-208	3/4-10	x 4	10	403-532A	7/8-9	x 8-1/2	1	403-554	1-1/8-7	x 7-1/2	1
400-209	3/4-10	x 4-1/2	10	403-533	7/8-9	x 9	1	403-555	1-1/4-7	x 2-1/2	1
400-210	3/4-10	x 5	10	403-534	7/8-9	x 10	1	400-233	1-1/4-7	x 3	1
400-211	3/4-10	x 5-1/2	10	400-224	1-8	x 2	10	400-234	1-1/4-7	x 3-1/2	1
400-212	3/4-10	x 6	10	403-535	1-8	x 2-1/4	10	400-235	1-1/4-7	x 4	1
403-519	3/4-10	x 6-1/2	5	400-225	1-8	x 2-1/2	10	403-556	1-1/4-7	x 4-1/2	1
400-213	3/4-10	x 7	5	403-536	1-8	x 2-3/4	10	400-236	1-1/4-7	x 5	1
403-520	3/4-10	x 7-1/2	5	400-226	1-8	x 3	10	403-557	1-1/4-7	x 5-1/2	1
400-214	3/4-10	x 8	5	403-537	1-8	x 3-1/4	10	400-237	1-1/4-7	x 6	1
403-521	3/4-10	x 9	1	400-227	1-8	x 3-1/2	10	403-558	1-1/4-7	x 7	1
403-522	3/4-10	x 10	1	403-538	1-8	x 3-3/4	5	403-559	1-1/4-7	x 8	1
403-523	7/8-9	x 1-1/2	10	400-228	1-8	x 4	5	403-559A	1-1/4-7	x 8-1/2	1
403-524	7/8-9	x 1-3/4	10	400-229	1-8	x 4-1/2	5	403-560	1-1/2-6	x 3	1
400-215	7/8-9	x 2	10	400-230	1-8	x 5	5	403-561	1-1/2-6	x 4	1
403-525	7/8-9	x 2-1/4	10	400-231	1-8	x 5-1/2	5	403-562	1-1/2-6	x 5	1
400-216	7/8-9	x 2-1/2	10	400-232	1-8	x 6	5	403-563	1-1/2-6	x 6	1
403-526	7/8-9	x 2-3/4	10	403-539	1-8	x 6-1/2	1	403-564	1-1/2-6	x 7	1
400-217	7/8-9	x 3	10	403-540	1-8	x 7	1				
				403-541	1-8	x 7-1/2	1				

**ÉCROUS HEXAGONE
U.N.C. / 18-8**

NUMÉRO	DIMENSION	BTE
400-252	3/4-10	20
400-254	7/8-9	10
400-256	1-8	10
400-258	1-1/8-7	1
400-259	1-1/4-7	1
400-260	1-1/2-6	1

**ÉCROUS BAGUE DE NYLON
U.N.C / 18-8**

NUMÉRO	DIMENSION	BTE
400-296	3/4-10	20
403-210	7/8-9	10
403-211	1-8	5
403-211A	1-1/8-7	1
403-212	1-1/4-7	1
404-790	1-1/2-6	1

**RONDELLES PLATES
18-8**

NUMÉRO	DIMENSION	BTE
400-317	3/4	20
400-318	7/8	20
400-319	1	10
400-320	1-1/8	10
400-321	1-1/4	10
400-322	1-1/2	10

**RONDELLES-RESSORTS
18-8**

NUMÉRO	DIMENSION	BTE
400-336	3/4	20
400-337	7/8	20
400-338	1	10
400-339	1-1/8	10
400-340	1-1/4	10
400-341	1-1/2	10

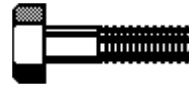
**BOULONS DE PRÉCISION HEXAGONAUX**
HEXAGON CAP SCREWSFILET FIN / FINE THREAD **U.N.F. (S.A.E.)**ACIER INOXYDABLE / STAINLESS STEEL **18-8 (304)****18-8****ACIER
INOXYDABLE
STAINLESS
STEEL**

NUMÉRO	DIMENSION			BTE	NUMÉRO	DIMENSION			BTE	NUMÉRO	DIMENSION			BTE
403-565	10-32	x	1/4	100	403-123	5/16-24	x	1/2	100	403-150	3/8-24	x	2-3/4	25
403-566	10-32	x	5/16	100	403-124	5/16-24	x	5/8	100	403-151	3/8-24	x	3	10
403-567	10-32	x	3/8	100	403-125	5/16-24	x	3/4	50	403-152	3/8-24	x	3-1/2	10
403-101	10-32	x	1/2	100	403-126	5/16-24	x	7/8	50	403-153	3/8-24	x	4	10
403-568	10-32	x	5/8	100	403-127	5/16-24	x	1	50	403-154	3/8-24	x	4-1/2	10
403-102	10-32	x	3/4	100	403-127A	5/16-24	x	1-1/4	50	403-155	3/8-24	x	5	10
403-569	10-32	x	7/8	100	403-129	5/16-24	x	1-1/2	50	403-156	3/8-24	x	6	10
403-103	10-32	x	1	100	403-130	5/16-24	x	1-3/4	50					
403-104	10-32	x	1-1/4	100	403-131	5/16-24	x	2	50	403-157	7/16-20	x	1	25
403-105	10-32	x	1-1/2	100	403-132	5/16-24	x	2-1/4	25	403-158	7/16-20	x	1-1/4	25
403-105A	10-32	x	2	100	403-133	5/16-24	x	2-1/2	25	403-159	7/16-20	x	1-1/2	25
					403-134	5/16-24	x	2-3/4	25	403-160	7/16-20	x	1-3/4	25
403-106	1/4-28	x	1/2	100	403-135	5/16-24	x	3	10	403-161	7/16-20	x	2	20
403-107	1/4-28	x	5/8	100	403-136	5/16-24	x	3-1/2	10	403-161A	7/16-20	x	2-1/4	20
403-108	1/4-28	x	3/4	100	403-137	5/16-24	x	4	10	403-162	7/16-20	x	2-1/2	20
403-109	1/4-28	x	7/8	100	403-138	5/16-24	x	4-1/2	10	403-163	7/16-20	x	3	10
403-110	1/4-28	x	1	100	403-139	5/16-24	x	5	10	403-163A	7/16-20	x	3-1/2	10
403-111	1/4-28	x	1-1/4	100	403-139A	5/16-24	x	5-1/2	10					
403-112	1/4-28	x	1-1/2	100	403-139B	5/16-24	x	6	10	403-164	1/2-20	x	3/4	25
403-113	1/4-28	x	1-3/4	100						403-165	1/2-20	x	1	25
403-114	1/4-28	x	2	100	403-140	3/8-24	x	1/2	50	403-166	1/2-20	x	1-1/4	25
403-115	1/4-28	x	2-1/4	50	403-141	3/8-24	x	5/8	50	403-167	1/2-20	x	1-1/2	25
403-116	1/4-28	x	2-1/2	50	403-142	3/8-24	x	3/4	50	403-168	1/2-20	x	1-3/4	25
403-117	1/4-28	x	2-3/4	50	403-570	3/8-24	x	7/8	50	403-169	1/2-20	x	2	20
403-118	1/4-28	x	3	25	403-143	3/8-24	x	1	50	403-170	1/2-20	x	2-1/4	20
403-119	1/4-28	x	3-1/2	25	403-144	3/8-24	x	1-1/4	25	403-171	1/2-20	x	2-1/2	20
403-120	1/4-28	x	4	25	403-145	3/8-24	x	1-1/2	25	403-172	1/2-20	x	2-3/4	20
403-121	1/4-28	x	4-1/2	10	403-146	3/8-24	x	1-3/4	25	403-173	1/2-20	x	3	10
403-122	1/4-28	x	5	10	403-147	3/8-24	x	2	25	403-173A	1/2-20	x	3-1/4	10
403-122A	1/4-28	x	5-1/2	10	403-148	3/8-24	x	2-1/4	25	403-174	1/2-20	x	3-1/2	10
403-122B	1/4-28	x	6	10	403-149	3/8-24	x	2-1/2	25	403-175	1/2-20	x	4	10

**ÉCROUS HEXAGONE**
U.N.F. / 18-8

NUMÉRO	DIMENSION	BTE
400-276	10-32	100
400-241	1/4-28	100
400-243	5/16-24	100
400-245	3/8-24	50
400-247	7/16-20	50
400-249	1/2-20	25

**ÉCROUS BAGUE DE NYLON**
U.N.F. / 18-8

NUMÉRO	DIMENSION	BTE
400-290	10-32	100
402-276	1/4-28	100
402-278	5/16-24	100
402-280	3/8-24	50
402-282	7/16-20	50
402-284	1/2-20	25

**RONDELLES PLATES**
18-8

NUMÉRO	DIMENSION	BTE
400-309	10	100
400-311	1/4	100
400-312	5/16	100
400-313	3/8	100
400-314	7/16	50
400-315	1/2	50

**RONDELLES-RESSORTS**
18-8

NUMÉRO	DIMENSION	BTE
400-329	10	100
400-330	1/4	100
400-331	5/16	100
400-332	3/8	100
400-333	7/16	50
400-334	1/2	50

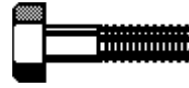
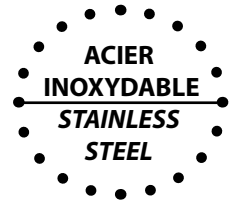
**BOULONS DE PRÉCISION HEXAGONAUX
HEXAGON CAP SCREWS**FILET FIN / FINE THREAD **U.N.F. (S.A.E.)**ACIER INOXYDABLE / STAINLESS STEEL **18-8 (304)****18-8**

NUMÉRO	DIMENSION	BTE	NUMÉRO	DIMENSION	BTE	NUMÉRO	DIMENSION	BTE
403-176	1/2-20 x 4-1/2	10	403-199	3/4-16 x 1-1/2	20	403-215	7/8-14 x 2	10
403-177	1/2-20 x 5	10	403-201	3/4-16 x 1-3/4	20	403-216	7/8-14 x 2-1/2	10
403-178	1/2-20 x 5-1/2	10	403-202	3/4-16 x 2	20	403-217	7/8-14 x 3	10
403-179	1/2-20 x 6	5	403-203	3/4-16 x 2-1/4	20	403-218	7/8-14 x 3-1/2	10
403-182	5/8-18 x 1	25	403-204	3/4-16 x 2-1/2	20	403-219	7/8-14 x 4	5
403-183	5/8-18 x 1-1/4	25	403-205A	3/4-16 x 2-3/4	20	403-220	7/8-14 x 4-1/2	5
403-184	5/8-18 x 1-1/2	25	403-206A	3/4-16 x 3	10	403-221	7/8-14 x 5	5
403-185	5/8-18 x 1-3/4	20	403-207A	3/4-16 x 3-1/2	10	403-222	7/8-14 x 5-1/2	5
403-186	5/8-18 x 2	20	403-208A	3/4-16 x 4	10	403-223	7/8-14 x 6	5
403-187	5/8-18 x 2-1/4	20	403-209A	3/4-16 x 4-1/2	10	403-224	1-14 x 2	10
403-188	5/8-18 x 2-1/2	20	403-210A	3/4-16 x 5	10	403-225	1-14 x 2-1/2	10
403-189	5/8-18 x 2-3/4	20	405-583	3/4-16 x 5-1/2	10	403-226	1-14 x 3	10
403-190	5/8-18 x 3	10	403-212A	3/4-16 x 6	10	403-227	1-14 x 3-1/2	10
403-191	5/8-18 x 3-1/2	10	403-213	3/4-16 x 7	5	403-228	1-14 x 4	5
403-192	5/8-18 x 4	10	403-214	3/4-16 x 8	5	403-229	1-14 x 4-1/2	5
403-193	5/8-18 x 4-1/2	10				403-230	1-14 x 5	5
403-194	5/8-18 x 5	10				403-231	1-14 x 5-1/2	5
403-195	5/8-18 x 5-1/2	10				403-232	1-14 x 6	5
403-196	5/8-18 x 6	10				403-233	1-1/4-12 x 3	1
403-197	5/8-18 x 7	5				403-234	1-1/4-12 x 3-1/2	1
403-198	5/8-18 x 8	5				403-235	1-1/4-12 x 4	1
						403-236	1-1/4-12 x 5	1
						403-237	1-1/4-12 x 6	1

**ÉCROUS HEXAGONE
U.N.F. / 18-8**

NUMÉRO	DIMENSION	BTE
400-249	1/2-20	25
400-251	5/8-18	25
400-253	3/4-16	20
400-255	7/8-14	10
400-257	1-14	10
403-582	1-1/4-12	1

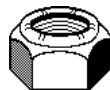
**ÉCROUS BAGUE DE NYLON
U.N.F. / 18-8**

NUMÉRO	DIMENSION	BTE
402-284	1/2-20	25
403-205	5/8-18	25
403-206	3/4-16	20
403-207	7/8-14	10
403-208	1-14	5
403-209	1-1/4-12	1

**RONDELLES PLATES
18-8**

NUMÉRO	DIMENSION	BTE
400-315	1/2	50
400-316	5/8	25
400-317	3/4	20
400-318	7/8	20
400-319	1	10
400-321	1-1/4	10

**RONDELLES-RESSORTS
18-8**

NUMÉRO	DIMENSION	BTE
400-334	1/2	50
400-335	5/8	25
400-336	3/4	20
400-337	7/8	20
400-338	1	10
400-340	1-1/4	10

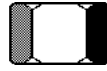
**ÉCROUS HEXAGONES**
HEXAGON NUTS**18-8**

ACIER INOXYDABLE / STAINLESS STEEL

FILET GROS / COARSE THREAD U.N.C. (U.S.S.)**FILET FIN / FINE THREAD U.N.F. (S.A.E.)**

NUMÉRO	DIMENSION	BTE	NUMÉRO	DIMENSION	BTE
400-240	1/4-20	100	400-241	1/4-28	100
400-242	5/16-18	100	400-243	5/16-24	100
400-244	3/8-16	50	400-245	3/8-24	50
400-246	7/16-14	50	400-247	7/16-20	50
400-248	1/2-13	25	400-249	1/2-20	25
403-576	9/16-12	25	403-580	9/16-18	25
400-250	5/8-11	25	400-251	5/8-18	25
400-252	3/4-10	20	400-253	3/4-16	20
400-254	7/8-9	10	400-255	7/8-14	10
400-256	1-8	10	403-581	1-12	10
400-258	1-1/8-7	1	400-257	1-14	10
400-259	1-1/4-7	1	403-582	1-1/4-12	1
400-260	1-1/2-6	1	403-583	1-1/2-12	1
403-577	1-3/4-5	1			

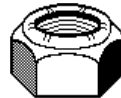
ÉCROUS AUTO-BLOQUANTS + NYLON
NYLON LOCKNUTS**18-8**

ACIER INOXYDABLE / STAINLESS STEEL

FILET GROS / COARSE THREAD
U.N.C. (U.S.S.)**FILET FIN / FINE THREAD**
U.N.F. (S.A.E.)

NUMÉRO	DIMENSION	BTE	NUMÉRO	DIMENSION	BTE	NUMÉRO	DIMENSION	BTE
403-584	2-56	100	400-294	1/2-13	25	400-290	10-32	100
400-286	4-40	100	400-294A	9/16-12	25	402-276	1/4-28	100
400-287	6-32	100	400-295	5/8-11	25	402-278	5/16-24	100
400-288	8-32	100	400-296	3/4-10	20	402-280	3/8-24	50
400-289	10-24	100	403-210	7/8-9	10	402-282	7/16-20	50
400-300	12-24	50	403-211	1-8	5	402-284	1/2-20	25
400-291	1/4-20	100	403-211A	1-1/8-7	1	403-426	9/16-18	25
400-292	5/16-18	100	403-212	1-1/4-7	1	403-205	5/8-18	25
400-293	3/8-16	50	404-790	1-1/2-6	1	403-206	3/4-16	25
400-293A	7/16-14	50				403-207	7/8-14	10
						403-208	1-14	5
						403-209	1-1/4-12	1

**ÉCROUS BORGNES**
ACORN CAP NUTS**18-8**

ACIER INOXYDABLE / STAINLESS STEEL

ÉCROUS À OREILLES
WING NUTS**18-8**

ACIER INOXYDABLE / STAINLESS STEEL

NUMÉRO	DIMENSION	FILET	BTE
403-585	4-40	NC	100
400-261	6-32	NC	100
400-262	8-32	NC	100
400-263	10-24	NC	100
400-264	10-32	NF	100
400-265	1/4-20	NC	100
403-586	1/4-28	NF	100
400-266	5/16-18	NC	100
400-267	3/8-16	NC	100
403-587	3/8-24	NF	100
400-268	1/2-13	NC	50
403-588	1/2-20	NF	50
400-269	5/8-11	NC	25
400-270	3/4-10	NC	

NUMÉRO	DIMENSION	FILET	BTE
400-278	6-32	NC	100
400-279	8-32	NC	100
400-280	10-24	NC	100
400-281	10-32	NF	100
400-282	1/4-20	NC	100
400-283	5/16-18	NC	100
400-284	3/8-16	NC	100
403-589	7/16-14	NC	50
400-285	1/2-13	NC	50
403-432	5/8-11	NC	25
403-433	3/4-10	NC	20

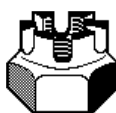
ÉCROUS À CRÉNEAUX
DÉGAGÉS
CASTLE NUTS**18-8**

ACIER INOXYDABLE / STAINLESS STEEL

ÉCROUS HEXAGONAUX
POUR VIS À MACHINE
HEX. MACHINE SCREWNUTS**18-8**

ACIER INOXYDABLE / STAINLESS STEEL

NUMÉRO	DIMENSION	FILET	BTE
400-297	1/4-20	NC	100
400-298	5/16-18	NC	100
400-299	3/8-16	NC	100
400-301	1/2-13	NC	50
400-302	5/8-11	NC	25
400-303	3/4-10	NC	20

NUMÉRO	DIMENSION	FILET	BTE
400-271	2-56	NC	100
400-271A	3-56	NC	100
400-272	4-40	NC	100
403-590	5-40	NC	100
400-273	6-32	NC	100
400-274	8-32	NC	100
400-275	10-24	NC	100
400-276	10-32	NF	100
400-277	12-24	NC	100
403-591	1/4-20	NC	100
403-592	5/16-18	NC	100
403-593	3/8-16	NC	100





RONDELLES PLATES
FLAT WASHER



18-8

ACIER INOXYDABLE / STAINLESS STEEL

RONDELLES RESSORTS
SPRING - LOCKWASHER



18-8

ACIER INOXYDABLE / STAINLESS STEEL

NUMÉRO	BOULON	I.D.	O.D.	ÉPAISSEUR	BTE	NUMÉRO	DIMENSION	BTE
400-305	2	0.094	0.250	0.016 - 0.025	100			
400-306	4	0.125	0.312	0.025 - 0.040	100	400-325	2	100
400-307	6	0.149	0.375	0.022 - 0.042	100	400-326	4	100
400-308	8	0.174	0.375	0.022 - 0.042	100	400-327	6	100
400-309	10	0.203	0.438	0.022 - 0.042	100	400-328	8	100
400-310	12	0.230	0.500	0.040 - 0.050	100	400-329	10	100
400-311	1/4	0.281	0.625	0.040 - 0.050	100	400-329A	12	100
400-312	5/16	0.345	0.750	0.045 - 0.055	100	400-330	1/4	100
400-313	3/8	0.390	0.875	0.057 - 0.067	100	400-331	5/16	100
400-314	7/16	0.469	1.125	0.057 - 0.067	50	400-332	3/8	100
400-315	1/2	0.563	1.250	0.068 - 0.088	50	400-333	7/16	50
400-315A	9/16	0.578	1.062	0.053 - 0.073	50	400-334	1/2	50
400-316	5/8	0.688	1.500	0.068 - 0.088	25	400-334A	9/16	50
400-317	3/4	0.813	1.750	0.095 - 0.115	20	400-335	5/8	25
400-317A	3/4		1.50	0	20	400-336	3/4	20
400-318	7/8	0.938	2.000	0.095 - 0.115	20	400-337	7/8	20
400-319	1	1.062	2.000	0.095 - 0.115	10	400-338	1	10
400-320	1-1/8	1.187	2.500	0.115 - 0.135	10	400-339	1-1/8	10
400-321	1-1/4	1.312	2.750	0.115 - 0.135	10	400-340	1-1/4	10
400-322	1-1/2	1.625	3.250	0.115 - 0.135	10	400-341	1-1/2	10

RONDELLES DE PARE-CHOC
FENDER WASHER



18-8



ACIER INOXYDABLE / STAINLESS STEEL

NUMÉRO	BOULON	O.D.	I.D.	ÉPAIS	BTE	NUMÉRO	BOULON	O.D.	I.D.	ÉPAIS	BTE
404-791B	6 x	5/8	.149	.031	100	402-475	5/16 x	1			100
404-792A	6 x	3/4	.174	.040	100	402-476A	5/16 x	1-1/4	.343	.045	100
						402-476	5/16 x	1-1/2	.343	.062	50
402-450	10 x	1/2	.203	.045	100	400-324	3/8 x	1	.406	.045	100
403-128	10 x	3/4	.203	.045	100	402-504	3/8 x	1-1/4	.406	.045	50
402-472	10 x	1	.203	.045	100	400-323	3/8 x	1-1/2	.406	.062	50
404-793	1/4 x	3/4	.281	.045	100	404-795	1/2 x	1-1/2	.531	.062	50
402-498	1/4 x	1	.281	.045	100	404-476	1/2 x	2	.531	.062	50
402-474	1/4 x	1-1/4	.281	.045	100						
402-474A	1/4 x	1-1/2			100						
						404-797	3/4 x	2	.812	.125	20

REV0523

**18-8****RONDELLES DE BLOCAGES À DENTURES
TOOTH LOCKWASHER****18-8**

ACIER INOXYDABLE / STAINLESS STEEL

INTERNE / INTERNAL			EXTERNE / EXTERNAL		
NUMÉRO	DIMENSION	BTE	NUMÉRO	DIMENSION	BTE
400-343	4	100	400-351	4	100
400-344	6	100	400-352	6	100
400-345	8	100	400-353	8	100
400-346	10	100	400-354	10	100
400-347	1/4	100	400-355	1/4	100
400-348	5/16	100	400-356	5/16	100
400-349	3/8	50	400-357	3/8	50
400-350	1/2	50	400-358	1/2	50

**RONDELLES HERMÉTIQUES
MASTER SEAL WASHERS****302****UTILISATION / USED:**

- AVEC VIS TÊTE HEXAGONE, RONDE OU PAN
- ÉTANCHE / SCELLE HERMÉTIQUEMENT
- USED WITH ROUND, PAN, OR HEX HEAD SCREWS
- AS WITH WEATHER SEAL FASTENERS.

COLLÉ SUR NÉOPRÈNE

ACIER INOXYDABLE / STAINLESS STEEL

NUMÉRO	VIS#	I.D.	O.D.	CALIBRE	BTE	VRAC	BTE
402-670	6	5/32	3/8	20	100	402-670V	25,000
402-672	8	11/64	3/8	20	100	402-672V	12,500
402-674	10	13/64	1/2	20	100	402-674V	12,500
402-675	12	7/32	5/8	20	100	402-675V	7,500
402-678	1/4	9/32	5/8	20	100	402-678V	7,500
402-678A	5/16						
402-679	1/4	1					

**RONDELLES À MADRIER
WASHER CONTERSUNK****RONDELLES À MADRIER À EMBASE
FLANGE WASHER CONTERSUNK**ACIER INOXYDABLE / STAINLESS STEEL **18-8 (304)**ACIER INOXYDABLE / STAINLESS STEEL **18-8 (304)**

NUMÉRO	DIMENSION	BTE	NUMÉRO	DIMENSION	BTE
404-791A	4	100	181-122	6	100
404-791	6	100	181-124	8	100
402-499	8	100	181-126	10	100
402-509	10	100			
402-496	12	100			
404-792	14	100			

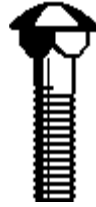
BOULONS DE CARROSSERIE
CARRIAGE BOLT

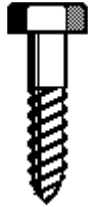
 ACIER INOXYDABLE
 STAINLESS STEEL

18-8
TIRE-FONDS TÊTE HEXAGONE
LAG SCREW HEXAGON HEAD

 ACIER INOXYDABLE
 STAINLESS STEEL

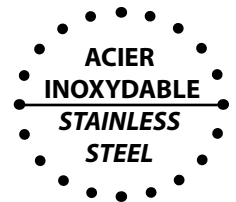
18-8

NUMÉRO	DIMENSION			BTE	NUMÉRO	DIMENSION			BTE
401-366	1/4-20	x	1/2	100	401-335	1/4	x	1	50
401-367	1/4-20	x	3/4	100	401-336	1/4	x	1-1/4	50
401-368	1/4-20	x	1	100	401-337	1/4	x	1-1/2	50
401-369	1/4-20	x	1-1/4	100	401-338	1/4	x	2	50
401-370	1/4-20	x	1-1/2	100	401-339	1/4	x	2-1/2	25
401-371	1/4-20	x	1-3/4	50	401-340	1/4	x	3	25
401-372	1/4-20	x	2	50	401-341	1/4	x	3-1/2	20
401-372A	1/4-20	x	2-1/4	50	401-342	1/4	x	4	20
401-373	1/4-20	x	2-1/2	50	401-343	1/4	x	5	20
401-374	1/4-20	x	3	50	401-344	5/16	x	1-1/2	50
401-375	1/4-20	x	3-1/2	50	401-345	5/16	x	2	50
401-376	1/4-20	x	4	25	401-346	5/16	x	2-1/2	25
401-377	5/16-18	x	3/4	50	401-347	5/16	x	3	25
401-378	5/16-18	x	1	50	401-347A	5/16	x	3-1/2	25
401-379	5/16-18	x	1-1/4	50	401-348	5/16	x	4	20
401-380	5/16-18	x	1-1/2	50	401-349	5/16	x	5	20
401-381	5/16-18	x	1-3/4	25	401-350	5/16	x	6	20
401-382	5/16-18	x	2	25	401-351	3/8	x	1-1/2	50
401-383	5/16-18	x	2-1/4	25	401-352	3/8	x	1-3/4	50
401-384	5/16-18	x	2-1/2	25	401-353	3/8	x	2	50
401-385	5/16-18	x	3	25	401-354	3/8	x	2-1/2	25
401-386	5/16-18	x	3-1/2	25	401-355	3/8	x	3	25
401-386A	5/16-18	x	4	25	401-356	3/8	x	4	20
401-387	3/8-16	x	3/4	50	401-357	3/8	x	5	20
401-388	3/8-16	x	1	50	401-358	3/8	x	6	20
401-389	3/8-16	x	1-1/4	25	401-358A	1/2	x	1-1/2	50
401-390	3/8-16	x	1-1/2	25	401-359	1/2	x	2	50
401-391	3/8-16	x	1-3/4	25	401-360	1/2	x	2-1/2	25
401-392	3/8-16	x	2	25	401-361	1/2	x	3	25
401-393	3/8-16	x	2-1/2	25	401-362	1/2	x	4	20
401-394	3/8-16	x	3	25	401-363	1/2	x	5	20
401-395	3/8-16	x	3-1/2	10	401-364	1/2	x	6	20
401-396	3/8-16	x	4	10					
401-397	3/8-16	x	5	10					
401-398	3/8-16	x	6	10					
401-399	1/2-13	x	1	25					
401-400	1/2-13	x	1-1/2	25					
401-401	1/2-13	x	2	25					
401-402	1/2-13	x	2-1/2	25					
401-403	1/2-13	x	3	25					
401-404	1/2-13	x	3-1/2	10					
401-405	1/2-13	x	4	10					
401-406	1/2-13	x	5	10					
401-407	1/2-13	x	6	10					



**FAUSSE VIS À TÊTE RONDE TYPE "U"**
DRIVE SCREW WITH ROUND HEAD

ACIER INOXYDABLE / STAINLESS STEEL

**18-8**

NUMÉRO	CALIBRE	LONG	POUCE	DRILL	BTE	NUMÉRO	CALIBRE	LONG	POUCE	DRILL	BTE
403-594	00	1/8	.052	55	100	403-600	6	3/16	.120	31	100
403-595	00	3/16	.052	55	100	401-314	6	1/4	.120	31	100
403-596	00	1/4	.052	55	100	403-601	6	5/16	.120	31	100
401-306	0	1/8	.073	51	100	401-315	6	3/8	.120	31	100
401-307	0	3/16	.073	51	100	401-316	6	1/2	.120	31	100
401-308	0	1/4	.073	51	100	403-602	8	1/4	.144	27	100
403-597	2	1/8	.086	44	100	401-317	8	3/8	.144	27	100
401-309	2	3/16	.086	44	100	401-318	8	1/2	.144	27	100
401-310	2	1/4	.086	44	100	403-603	10	3/8	.161	20	100
401-311	4	3/16	.104	37	100	401-319	10	1/2	.161	20	100
401-312	4	1/4	.104	37	100						
403-598	4	5/16	.104	37	100						
403-599	4	3/8	.104	37	100						
401-313	4	7/16	.114	37	100						



VIS À MACHINE À TÊTE PLATE / FENDUE
MACHINE SCREWS FLAT HEAD / SLOTTED

ACIER INOXYDABLE / STAINLESS STEEL

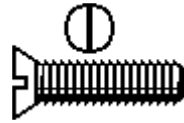
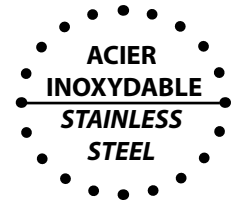
**18-8**

NUMÉRO	DIMENSIONBTE	NUMÉRO	DIMENSIONBTE	NUMÉRO	DIMENSIONBTE
403-604	2-56 x 1/8 100	403-619	8-32 x 1-3/4 50	403-640	1/4-20 x 3/8 100
400-481	2-56 x 3/16 100	400-509	8-32 x 2 50	400-526	1/4-20 x 1/2 100
400-482	2-56 x 1/4 100	403-620	8-32 x 2-1/4 50	403-641	1/4-20 x 5/8 100
403-605	2-56 x 5/16 100	403-621	8-32 x 2-1/2 25	400-527	1/4-20 x 3/4 100
400-483	2-56 x 3/8 100	403-622	8-32 x 3 25	403-642	1/4-20 x 7/8 100
403-606	2-56 x 7/16 100			400-528	1/4-20 x 1 100
400-484	2-56 x 1/2 100	403-623	10-24 x 1/4 100	400-529	1/4-20 x 1-1/4 100
400-485	2-56 x 3/4 100	403-624	10-24 x 5/16 100	400-530	1/4-20 x 1-1/2 100
		400-510	10-24 x 3/8 100	400-531	1/4-20 x 1-3/4 50
400-486	4-40 x 3/16 100	400-511	10-24 x 1/2 100	400-532	1/4-20 x 2 50
400-487	4-40 x 1/4 100	403-625	10-24 x 5/8 100	403-643	1/4-20 x 2-1/4 50
403-607	4-40 x 5/16 100	400-512	10-24 x 3/4 100	400-533	1/4-20 x 2-1/2 50
400-488	4-40 x 3/8 100	403-626	10-24 x 7/8 100	403-644	1/4-20 x 2-3/4 25
403-608	4-40 x 7/16 100	400-513	10-24 x 1 100	400-534	1/4-20 x 3 25
400-489	4-40 x 1/2 100	400-514	10-24 x 1-1/4 100	400-997	1/4-20 x 3-1/2 25
403-609	4-40 x 5/8 100	400-515	10-24 x 1-1/2 100	401-421	1/4-20 x 4 25
400-490	4-40 x 3/4 100	403-627	10-24 x 1-3/4 50	403-645	1/4-20 x 4-1/2 25
403-610	4-40 x 7/8 100	400-516	10-24 x 2 50	403-646	1/4-20 x 5 25
400-491	4-40 x 1 100	400-517	10-24 x 2-1/2 25		
403-611	4-40 x 1-1/2 100	400-517A	10-24 x 2-3/4 25	403-647	5/16-18 x 1/2 50
		400-518	10-24 x 3 25	403-648	5/16-18 x 5/8 50
403-612	6-32 x 3/16 100	401-418	10-24 x 3-1/2 25	401-226	5/16-18 x 3/4 50
400-492	6-32 x 1/4 100	403-628	10-24 x 4 25	403-649	5/16-18 x 7/8 50
403-613	6-32 x 5/16 100	403-628B	10-24 x 5 25	401-151	5/16-18 x 1 50
400-493	6-32 x 3/8 100			401-152	5/16-18 x 1-1/4 50
400-494	6-32 x 1/2 100	403-629	12-24 x 1/2 100	401-153	5/16-18 x 1-1/2 50
403-614	6-32 x 5/8 100	403-630	12-24 x 5/8 100	403-650	5/16-18 x 1-3/4 25
400-495	6-32 x 3/4 100	403-631	12-24 x 3/4 100	401-154	5/16-18 x 2 25
400-496	6-32 x 1 100	403-632	12-24 x 1 100	403-651	5/16-18 x 2-1/4 25
400-497	6-32 x 1-1/4 100	403-633	12-24 x 1-1/4 100	401-155	5/16-18 x 2-1/2 25
400-498	6-32 x 1-1/2 100	403-634	12-24 x 1-1/2 100	401-156	5/16-18 x 3 25
400-499	6-32 x 2 50	403-635	12-24 x 2 50	403-652	5/16-18 x 3-1/2 25
403-615	6-32 x 2-1/2 50	403-636	12-24 x 2-1/2 25	402-272	5/16-18 x 4 25
400-501	8-32 x 1/4 100	403-637	10-32 x 1/4 100	403-653	3/8-16 x 1/2 25
403-616	8-32 x 5/16 100	400-519	10-32 x 3/8 100	403-654	3/8-16 x 5/8 25
400-502	8-32 x 3/8 100	400-520	10-32 x 1/2 100	401-157	3/8-16 x 3/4 25
403-617	8-32 x 7/16 100	403-638	10-32 x 5/8 100	403-655	3/8-16 x 7/8 25
400-503	8-32 x 1/2 100	400-521	10-32 x 3/4 100	401-158	3/8-16 x 1 25
400-504	8-32 x 5/8 100	403-639	10-32 x 7/8 100	401-159	3/8-16 x 1-1/4 25
400-505	8-32 x 3/4 100	400-522	10-32 x 1 100	401-160	3/8-16 x 1-1/2 25
403-618	8-32 x 7/8 100	400-523	10-32 x 1-1/4 100	403-656	3/8-16 x 1-3/4 25
400-506	8-32 x 1 100	400-524	10-32 x 1-1/2 100	401-161	3/8-16 x 2 25
400-507	8-32 x 1-1/4 100	400-525	10-32 x 2 50	403-657	3/8-16 x 2-1/4 25
400-508	8-32 x 1-1/2 100	401-419	10-32 x 2-1/2 25	401-162	3/8-16 x 2-1/2 25
		401-420	10-32 x 3 25		

REV0523

**VIS À MACHINE À TÊTE PLATE / FENDUE**
MACHINE SCREWS FLAT HEAD / SLOTTED

ACIER INOXYDABLE / STAINLESS STEEL

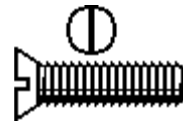
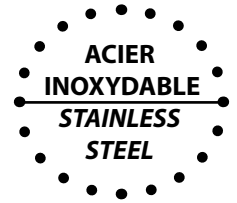
**18-8**

NUMÉRO	DIMENSION	BTE		NUMÉRO	DIMENSION	BTE		NUMÉRO	DIMENSION	BTE				
403-658	3/8-16	x	2-3/4	25	403-664	5/8-11	x	1	25	403-667	3/4-10	x	1-1/2	20
401-163	3/8-16	x	3	25	401-171	5/8-11	x	1-1/4	25	403-668	3/4-10	x	2	20
403-659	3/8-16	x	3-1/2	25	401-172	5/8-11	x	1-1/2	25	403-669	3/4-10	x	2-1/2	20
403-660	3/8-16	x	4	25	403-665	5/8-11	x	1-3/4	25	403-670	3/4-10	x	3	20
403-661	1/2-13	x	3/4	25	401-173	5/8-11	x	2	25	403-671	3/4-10	x	3-1/2	20
401-164	1/2-13	x	1	25	401-174	5/8-11	x	2-1/2	25	403-672	3/4-10	x	4	20
401-165	1/2-13	x	1-1/4	25	401-175	5/8-11	x	3	10					
401-166	1/2-13	x	1-1/2	25	403-666	5/8-11	x	3-1/2	10					
403-662	1/2-13	x	1-3/4	25	401-176	5/8-11	x	4	10					
401-167	1/2-13	x	2	25										
401-168	1/2-13	x	2-1/2	25										
401-169	1/2-13	x	3	25										
403-663	1/2-13	x	3-1/2	25										
401-170	1/2-13	x	4	25										



VIS À MACHINE À TÊTE PLATE / ÉTOILÉE
MACHINE SCREWS FLAT HEAD / PHILLIPS

ACIER INOXYDABLE / STAINLESS STEEL

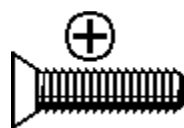
**18-8**

NUMÉRO	DIMENSIONBTE	NUMÉRO	DIMENSIONBTE	NUMÉRO	DIMENSIONBTE
403-673	2-56 x 1/8 100	401-770	8-32 x 1-1/2 100	403-442	1/4-20 x 1-3/4 50
403-434	2-56 x 3/16 100	401-772	8-32 x 1-3/4 50	402-232	1/4-20 x 2 50
403-435	2-56 x 1/4 100	401-774	8-32 x 2 50	403-698	1/4-20 x 2-1/4 50
403-674	2-56 x 5/16 100	402-655	8-32 x 2-1/4 50	402-258	1/4-20 x 2-1/2 50
403-436	2-56 x 3/8 100	402-656	8-32 x 2-1/2 25	402-260	1/4-20 x 3 25
403-437	2-56 x 1/2 100	403-689	10-24 x 1/4 100	403-443	1/4-20 x 3-1/2 25
403-438	2-56 x 3/4 100	403-690	10-24 x 5/16 100	403-444	1/4-20 x 4 25
403-439	4-40 x 3/16 100	402-657	10-24 x 3/8 100	403-699	5/16-18 x 1/2 50
402-238	4-40 x 1/4 100	401-210	10-24 x 1/2 100	403-445	5/16-18 x 3/4 50
403-675	4-40 x 5/16 100	402-658	10-24 x 5/8 100	402-296	5/16-18 x 1 50
403-440	4-40 x 3/8 100	401-211	10-24 x 3/4 100	403-446	5/16-18 x 1-1/4 50
403-676	4-40 x 7/16 100	401-212	10-24 x 1 100	403-447	5/16-18 x 1-1/2 50
402-240	4-40 x 1/2 100	401-776	10-24 x 1-1/4 100	401-745	5/16-18 x 2 25
403-677	4-40 x 5/8 100	401-730	10-24 x 1-1/2 100	401-749	5/16-18 x 2-1/2 25
402-242	4-40 x 3/4 100	402-659	10-24 x 1-3/4 50	403-448	5/16-18 x 3 25
402-244	4-40 x 1 100	401-734	10-24 x 2 50	403-700	5/16-18 x 3-1/2 25
403-678	4-40 x 1-1/4 100	401-778	10-24 x 2-1/2 25	405-584	5/16-18 x 4 25
403-679	4-40 x 1-1/2 100	402-250	10-24 x 3 25		
403-680	6-32 x 3/16 100	403-441	10-24 x 3-1/2 25		
401-201	6-32 x 1/4 100	403-691	10-32 x 1/4 100		
403-681	6-32 x 5/16 100	403-692	10-32 x 5/16 100		
401-202	6-32 x 3/8 100	402-660	10-32 x 3/8 100		
403-682	6-32 x 7/16 100	403-693	10-32 x 7/16 100		
401-203	6-32 x 1/2 100	401-213	10-32 x 1/2 100		
403-683	6-32 x 5/8 100	402-661	10-32 x 5/8 100		
401-204	6-32 x 3/4 100	401-214	10-32 x 3/4 100		
403-684	6-32 x 7/8 100	403-694	10-32 x 7/8 100		
401-205	6-32 x 1 100	401-215	10-32 x 1 100		
401-653	6-32 x 1-1/4 100	401-738	10-32 x 1-1/4 100		
401-710	6-32 x 1-1/2 100	401-740	10-32 x 1-1/2 100		
402-654	6-32 x 1-3/4 50	402-662	10-32 x 1-3/4 50		
401-711	6-32 x 2 50	402-254	10-32 x 2 50		
402-269	8-32 x 3/16 100	402-254A	10-32 x 2-1/4 50		
402-270	8-32 x 1/4 100	402-256	10-32 x 2-1/2 25		
403-685	8-32 x 5/16 100	402-663	10-32 x 3 25		
401-206	8-32 x 3/8 100	403-695	1/4-20 x 3/8 100		
403-686	8-32 x 7/16 100	401-700	1/4-20 x 1/2 100		
401-207	8-32 x 1/2 100	403-696	1/4-20 x 5/8 100		
403-687	8-32 x 5/8 100	401-216	1/4-20 x 3/4 100		
401-208	8-32 x 3/4 100	403-697	1/4-20 x 7/8 100		
403-688	8-32 x 7/8 100	401-217	1/4-20 x 1 100		
401-209	8-32 x 1 100	401-218	1/4-20 x 1-1/4 100		
401-768	8-32 x 1-1/4 100	401-219	1/4-20 x 1-1/2 100		

REV0523

**VIS À MACHINE À TÊTE OVALE/ ÉTOILÉE
MACHINE SCREWS OVAL HEAD / PHILLIPS**

ACIER INOXYDABLE / STAINLESS STEEL

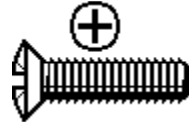
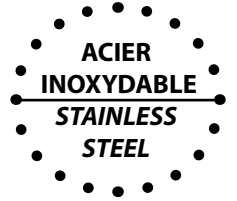
**18-8**

NUMÉRO	DIMENSIONBTE	NUMÉRO	DIMENSIONBTE	NUMÉRO	DIMENSIONBTE
403-701	6-32 x 1/4 100	403-708	10-24 x 3/8 100	400-549	1/4-20 x 3/4 100
400-535	6-32 x 3/8 100	400-543	10-24 x 1/2 100	400-551	1/4-20 x 1 100
400-536	6-32 x 1/2 100	403-709	10-24 x 5/8 100	400-552	1/4-20 x 1-1/4 100
403-702	6-32 x 5/8 100	400-544	10-24 x 3/4 100	400-553	1/4-20 x 1-1/2 100
400-537	6-32 x 3/4 100	400-545	10-24 x 1 100	403-715	1/4-20 x 1-3/4 50
400-538	6-32 x 1 100	403-710	10-24 x 1-1/4 100	403-716	1/4-20 x 2 50
402-515	6-32 x 1-1/4 100	401-651	10-24 x 1-1/2 100	403-717	1/4-20 x 2-1/2 50
		403-711	10-24 x 1-3/4 50	402-500	1/4-20 x 3 25
400-539	8-32 x 3/8 100	403-712	10-24 x 2 50		
400-540	8-32 x 1/2 100	403-713	10-24 x 2-1/2 25		
403-703	8-32 x 5/8 100	402-294	10-24 x 3 25		
400-541	8-32 x 3/4 100				
403-704	8-32 x 7/8 100	400-546	10-32 x 1/2 100		
400-542	8-32 x 1 100	403-714	10-32 x 5/8 100		
403-705	8-32 x 1-1/4 100	400-547	10-32 x 3/4 100		
403-706	8-32 x 1-1/2 100	400-548	10-32 x 1 100		
403-707	8-32 x 2 50	401-609	10-32 x 1-1/4 100		
403-707A	8-32 x 2-1/2 50	401-610	10-32 x 1-1/2 100		
		402-274	10-32 x 2 50		



VIS À MACHINE À TÊTE PAN / FENDUE
MACHINE SCREWS PAN HEAD / SLOTTED

ACIER INOXYDABLE / STAINLESS STEEL

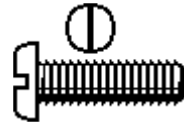

18-8

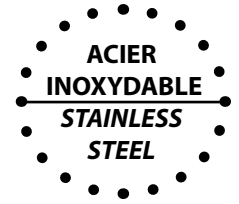

NUMÉRO	DIMENSIONBTE				NUMÉRO	DIMENSIONBTE				NUMÉRO	DIMENSIONBTE			
403-718	2-56	x	1/8	100	400-424	8-32	x	1/4	100	403-753	12-24	x	1/2	100
400-401	2-56	x	3/16	100	403-736	8-32	x	5/16	100	400-452A	12-24	X	3/4	100
400-402	2-56	x	1/4	100	400-425	8-32	x	3/8	100	403-754	12-24	x	1	100
403-719	2-56	x	5/16	100	403-737	8-32	x	7/16	100	403-755	1/4-20	x	3/8	100
400-403	2-56	x	3/8	100	400-426	8-32	x	1/2	100	403-756	1/4-20	x	7/16	100
403-720	2-56	x	7/16	100	400-427	8-32	x	5/8	100	400-453	1/4-20	x	1/2	100
400-404	2-56	x	1/2	100	400-428	8-32	x	3/4	100	400-454	1/4-20	X	5/8	100
403-721	2-56	x	5/8	100	403-738	8-32	x	7/8	100	400-455	1/4-20	x	3/4	100
400-405	2-56	x	3/4	100	400-429	8-32	x	1	100	403-757	1/4-20	x	7/8	100
403-722	4-40	x	1/8	100	400-431	8-32	x	1-1/4	100	400-456	1/4-20	x	1	100
400-406	4-40	x	3/16	100	400-432	8-32	x	1-1/2	100	400-457	1/4-20	x	1-1/4	100
400-407	4-40	x	1/4	100	403-739	8-32	x	1-3/4	50	400-458	1/4-20	x	1-1/2	100
403-723	4-40	x	5/16	100	400-433	8-32	x	2	50	400-459	1/4-20	x	1-3/4	50
400-409	4-40	x	3/8	100	403-740	8-32	x	2-1/2	25	400-461	1/4-20	x	2	50
403-724	4-40	x	7/16	100	403-741	8-32	x	3	25	403-758	1/4-20	x	2-1/4	50
400-411	4-40	x	1/2	100	403-742	10-24	x	1/4	100	400-462	1/4-20	x	2-1/2	50
400-412	4-40	x	5/8	100	400-434	10-24	x	3/8	100	400-463	1/4-20	x	3	25
400-413	4-40	x	3/4	100	403-743	10-24	x	7/16	100	403-759	5/16-18	x	1/2	50
403-725	4-40	x	7/8	100	400-435	10-24	x	1/2	100	400-464	5/16-18	x	3/4	50
400-414	4-40	x	1	100	400-436	10-24	X	5/8	100	400-465	5/16-18	x	1	50
403-726	4-40	x	1-1/4	100	400-437	10-24	x	3/4	100	400-466	5/16-18	x	1-1/4	50
403-727	4-40	x	1-1/2	100	400-438	10-24	x	1	100	400-467	5/16-18	x	1-1/2	50
403-728	4-40	x	2	100	400-439	10-24	x	1-1/4	100	400-468	5/16-18	x	2	25
403-729	6-32	x	3/16	100	400-440	10-24	x	1-1/2	100	400-469	5/16-18	x	2-1/2	25
400-415	6-32	x	1/4	100	403-744	10-24	x	1-3/4	50	400-470	5/16-18	x	3	25
403-730	6-32	x	5/16	100	400-441	10-24	x	2	50	400-471	3/8-16	x	3/4	25
400-416	6-32	x	3/8	100	400-442	10-24	x	2-1/2	25	400-472	3/8-16	x	1	25
403-731	6-32	x	7/16	100	400-443	10-24	x	3	25	400-473	3/8-16	x	1-1/4	25
400-417	6-32	x	1/2	100	400-444A	10-24	x	2-3/4	25	400-474	3/8-16	x	1-1/2	25
400-418	6-32	X	5/8	100	400-443	10-24	x	3	25	400-475	3/8-16	x	2	25
400-419	6-32	x	3/4	100	403-745	10-32	x	1/4	100					
403-732	6-32	x	7/8	100	403-746	10-32	x	5/16	100					
400-420	6-32	x	1	100	403-747	10-32	x	3/8	100					
400-421	6-32	x	1-1/4	100	403-748	10-32	x	7/16	100					
400-422	6-32	x	1-1/2	100	400-445	10-32	x	1/2	100					
403-733	6-32	x	1-3/4	100	400-446	10-32	X	5/8	100					
400-423	6-32	x	2	100	400-447	10-32	x	3/4	100					
403-734	6-32	x	2-1/4	100	400-448	10-32	x	1	100					
403-735	6-32	x	2-1/2	100	400-449	10-32	x	1-1/4	100					
					400-451	10-32	x	1-1/2	100					
					403-749	10-32	x	1-3/4	50					
					400-452	10-32	x	2	50					
					403-750	10-32	x	2-1/4	25					
					403-751	10-32	x	2-1/2	25					
					403-752	10-32	x	3	25					

REV0523

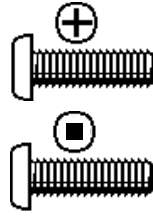
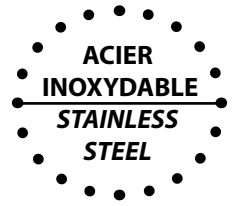
**VIS À MACHINE À TÊTE PAN**
MACHINE SCREWS PAN HEADACIER INOXYDABLE
STAINLESS STEEL**ÉTOILÉE / PHILLIPS****CARRÉE / SQUARES**
PRISE CARRÉE, AJOUTER "SQ"
À LA FIN DU NUMÉRO**18-8**

NUMÉRO	DIMENSIONBTE				NUMÉRO	DIMENSIONBTE				NUMÉRO	DIMENSIONBTE			
403-760	2-56	x	1/8	100	400-578	8-32	x	5/8	100	402-643	12-24	x	3/4	100
400-554	2-56	x	3/16	100	400-579	8-32	x	3/4	100	402-644	12-24	x	1	100
400-556	2-56	x	1/4	100	403-775	8-32	x	7/8	100	402-645	12-24	x	1-1/2	100
403-761	2-56	x	5/16	100	400-580	8-32	x	1	100	402-646	12-24	x	2	50
400-558	2-56	x	3/8	100	400-580A	8-32	x	1-1/4	100	402-647	12-24	x	2-1/2	25
403-762	2-56	x	7/16	100	400-500	8-32	x	1-1/2	100	402-648	12-24	x	3	25
400-559	2-56	x	1/2	100	400-579A	8-32	x	1-3/4	50					
403-763	2-56	x	5/8	100	401-408	8-32	x	2	50	403-782A	1/4-20	x	5/16	100
403-251	2-56	x	3/4	100	402-652	8-32	x	2-1/4	50	403-782	1/4-20	x	3/8	100
					402-637	8-32	x	2-1/2	25	400-591	1/4-20	x	1/2	100
403-764	4-40	x	1/8	100	402-638	8-32	x	3	25	400-593	1/4-20	x	5/8	100
400-561	4-40	x	3/16	100						400-594	1/4-20	x	3/4	100
400-562	4-40	x	1/4	100	403-776	10-24	x	1/4	100	403-783	1/4-20	x	7/8	100
403-765	4-40	x	5/16	100	403-777	10-24	x	5/16	100	400-595	1/4-20	x	1	100
400-563	4-40	x	3/8	100	400-581	10-24	x	3/8	100	400-596	1/4-20	x	1-1/4	100
403-766	4-40	x	7/16	100	400-582	10-24	x	1/2	100	400-597	1/4-20	x	1-1/2	100
400-564	4-40	x	1/2	100	400-583	10-24	x	5/8	100	402-248	1/4-20	x	1-3/4	50
400-565	4-40	x	5/8	100	400-584	10-24	x	3/4	100	401-415	1/4-20	x	2	50
400-566	4-40	x	3/4	100	403-778	10-24	x	7/8	100	403-784	1/4-20	x	2-1/4	50
403-767	4-40	x	7/8	100	400-585	10-24	x	1	100	401-416	1/4-20	x	2-1/2	50
400-566A	4-40	x	1	100	403-253	10-24	x	1-1/4	100	401-417	1/4-20	x	3	25
403-768	4-40	x	1-1/4	100	401-409	10-24	x	1-1/2	100	402-649	1/4-20	x	3-1/2	25
403-769	4-40	x	1-1/2	100	401-492	10-24	x	1-3/4	50	402-650	1/4-20	x	4	25
					401-410	10-24	x	2	50					
403-770	6-32	x	3/16	100	402-246	10-24	x	2-1/2	25	403-785	5/16-18	x	1/2	50
400-567	6-32	x	1/4	100	402-639	10-24	x	3	25	403-786	5/16-18	x	5/8	50
403-771	6-32	x	5/16	100	402-640	10-24	x	3-1/2	25	403-254	5/16-18	x	3/4	50
400-568	6-32	x	3/8	100						403-255	5/16-18	x	1	50
403-772	6-32	x	7/16	100	400-585A	10-32	x	1/4	100	403-256	5/16-18	x	1-1/4	50
400-571	6-32	x	1/2	100	403-779	10-32	x	5/16	100	403-257	5/16-18	x	1-1/2	50
400-572	6-32	x	5/8	100	400-586	10-32	x	3/8	100	403-787	5/16-18	x	1-3/4	25
400-573	6-32	x	3/4	100	400-587	10-32	x	1/2	100	403-258	5/16-18	x	2	25
403-773	6-32	x	7/8	100	400-588	10-32	x	5/8	100	403-259	5/16-18	x	2-1/2	25
400-574	6-32	x	1	100	400-589	10-32	x	3/4	100	403-260	5/16-18	x	3	25
400-574A	6-32	x	1-1/4	100	403-780	10-32	x	7/8	100	403-788	5/16-18	x	3-1/2	25
402-264	6-32	x	1-1/2	100	400-590	10-32	x	1	100	403-261	5/16-18	x	4	25
403-252	6-32	x	1-3/4	50	402-230	10-32	x	1-1/4	100					
402-266	6-32	x	2	50	401-411	10-32	x	1-1/2	100	403-789	3/8-16	x	1/2	25
402-635	6-32	x	2-1/2	50	402-494	10-32	x	1-3/4	50	403-790	3/8-16	x	5/8	25
402-636	6-32	x	3	50	401-412	10-32	x	2	50	403-262	3/8-16	x	3/4	25
					403-781	10-32	x	2-1/4	50	403-263	3/8-16	x	1	25
400-575	8-32	x	1/4	100	401-413	10-32	x	2-1/2	25	403-264	3/8-16	x	1-1/4	25
403-774	8-32	x	5/16	100	401-414	10-32	x	3	25	403-265	3/8-16	x	1-1/2	25
400-576	8-32	x	3/8	100	402-641	10-32	x	3-1/2	25	403-791	3/8-16	x	1-3/4	25
400-577	8-32	x	1/2	100	402-642	10-32	x	4	25	403-266	3/8-16	x	2	25
										403-267	3/8-16	x	2-1/2	25
										403-268	3/8-16	x	3	25

**VIS À MACHINE À TÊTE TRUSS / ÉTOILÉE**
MACHINE SCREWS TRUSS HEAD / PHILLIPS

ACIER INOXYDABLE / STAINLESS STEEL

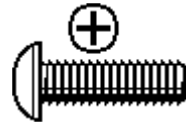
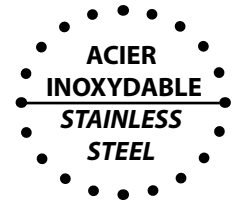
**18-8**

NUMÉRO	DIMENSION	BTE	NUMÉRO	DIMENSION	BTE	NUMÉRO	DIMENSION	BTE
402-102	6-32	x 1/4	402-150	10-24	x 3/8	402-210	1/4-20	x 1/2
402-104	6-32	x 5/16	402-152	10-24	x 1/2	402-212	1/4-20	x 5/8
402-106	6-32	x 3/8	402-154	10-24	x 5/8	402-214	1/4-20	x 3/4
402-108	6-32	x 1/2	402-156	10-24	x 3/4	402-216	1/4-20	x 1
402-109	6-32	x 3/4	402-158	10-24	x 1	402-218	1/4-20	x 1-1/4
402-110	6-32	x 1	402-159	10-24	x 1-1/4	402-220	1/4-20	x 1-1/2
402-111	6-32	x 1-1/4	402-160	10-24	x 1-1/2	402-221	1/4-20	x 1-3/4
402-112	6-32	x 1-1/2	402-161	10-24	x 1-3/4	402-222	1/4-20	x 2
402-113	6-32	x 1-3/4	402-162	10-24	x 2	402-223	1/4-20	x 2-1/2
402-114	6-32	x 2	402-163	10-24	x 2-1/2	402-224	1/4-20	x 3
			402-164	10-24	x 3			
402-123	8-32	x 3/16	402-165	10-24	x 3-1/2			
402-124	8-32	x 1/4						
402-126	8-32	x 5/16	402-179	10-32	x 1/4			
402-128	8-32	x 3/8	402-180	10-32	x 3/8			
402-130	8-32	x 1/2	402-182	10-32	x 1/2			
402-132	8-32	x 5/8	402-184	10-32	x 5/8			
402-134	8-32	x 3/4	402-186	10-32	x 3/4			
403-792	8-32	x 7/8	402-188	10-32	x 1			
402-136	8-32	x 1	402-189	10-32	x 1-1/4			
402-137	8-32	x 1-1/4	402-190	10-32	x 1-1/2			
402-138	8-32	x 1-1/2	402-191	10-32	x 1-3/4			
402-139	8-32	x 1-3/4	402-192	10-32	x 2			
402-140	8-32	x 2	402-193	10-32	x 2-1/2			
402-141	8-32	x 2-1/4	402-194	10-32	x 3			
402-142	8-32	x 2-1/2						

VIS À PATIO À TÊTE BUGLE / CARRÉE
DECK SCREWS BUGLE HEAD / SQUARE**POINTE COUPANTE / CUTTER POINT**

ACIER INOXYDABLE / STAINLESS STEEL

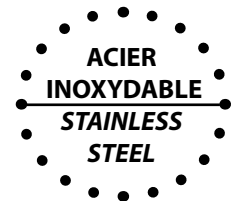
TYPE 17**18-8**

NUMÉRO	DIMENSION	BTE	NUMÉRO	DIMENSION	BTE	NUMÉRO	DIMENSION	BTE
405-150	6	x 1-1/4	405-153	8	x 1-5/8	405-158	10	x 2-1/2
405-151	6	x 1-5/8	405-154	8	x 2	405-159	10	x 3
405-152	6	x 2	405-155	8	x 2-1/4	405-160	10	x 3-1/2
			405-156	8	x 2-1/2	405-161	10	x 4
			405-157	8	x 3			

NOTE: Tous ces NUMÉROS sont aussi disponibles en vrac

REV0523

**VIS À MÉTAL À TÊTE PLATE / ÉTOILÉE**
TAPPING SCREWS FLAT HEAD / PHILLIPS

ACIER INOXYDABLE / STAINLESS STEEL

**18-8**

NUMÉRO	DIMENSIONBTE	NUMÉRO	DIMENSIONBTE	NUMÉRO	DIMENSIONBTE
403-800	4 x 3/8 100	400-655	8 x 3/4 100	402-324	12 x 3/4 100
400-648	4 x 1/2 100	400-656	8 x 1 100	402-326	12 x 1 100
403-801	4 x 5/8 100	400-657	8 x 1-1/4 100	401-760	12 x 1-1/4 100
400-649	4 x 3/4 100	400-659	8 x 1-1/2 100	401-764	12 x 1-1/2 100
403-802	4 x 1 100	402-316	8 x 1-3/4 100	402-328	12 x 2 100
		402-318	8 x 2 100	402-330	12 x 2-1/2 50
		403-809	8 x 2-1/2 50	402-338	12 x 3 50
403-803	6 x 3/8 100	403-810	8 x 3 50		
400-651	6 x 1/2 100			403-310	14 x 3/4 100
403-804	6 x 5/8 100	402-320	10 x 1/2 100	403-310A	14 x 1 100
400-652	6 x 3/4 100	400-661	10 x 3/4 100	403-311	14 x 1-1/4 100
405-250	6 x 3/4 100	400-662	10 x 1 100	402-332	14 x 1-1/2 100
400-653	6 x 1 100	400-663	10 x 1-1/4 100	403-312	14 x 1-3/4 100
403-805	6 x 1-1/4 100	400-665	10 x 1-1/2 100	403-313	14 x 2 100
403-806	6 x 1-1/2 100	402-541	10 x 1-3/4 100	403-314	14 x 2-1/2 50
		400-666	10 x 2 100	402-448	14 x 3 50
403-807	8 x 3/8 100	402-322	10 x 2-1/2 50		
400-654	8 x 1/2 100	403-811	10 x 3 50		
403-808	8 x 5/8 100				

VIS À MÉTAL À TÊTE PLATE / CARRÉE
TAPPING SCREWS FLAT HEAD / SOCKET

ACIER INOXYDABLE / STAINLESS STEEL

**18-8**

NUMÉRO	DIMENSIONBTE	NUMÉRO	DIMENSIONBTE	NUMÉRO	DIMENSIONBTE
405-197	4 x 3/4 100	401-248	8 x 2 100	401-423	12 x 3/4 100
401-238	6 x 3/8 100	401-249	8 x 2-1/2 50	401-424	12 x 1 100
401-239	6 x 1/2 100	401-250	8 x 3 50	401-425	12 x 1-1/4 100
401-239A	6 x 5/8 100			401-426	12 x 1-1/2 100
401-240	6 x 3/4 100	401-251	10 x 1/2 100	401-427	12 x 1-3/4 100
401-241	6 x 1 100	401-252	10 x 5/8 100	401-428	12 x 2 100
401-241A	6 x 1-1/4 100	401-253	10 x 3/4 100	401-429	12 x 2-1/2 50
401-241B	6 x 1-1/2 100	401-254	10 x 1 100	401-430	12 x 3 50
		401-255	10 x 1-1/4 100		
403-812	8 x 3/8 100	401-256	10 x 1-1/2 100	401-431	14 x 3/4 100
401-242	8 x 1/2 100	401-256A	10 x 1-3/4 100	401-432	14 x 1 100
401-243	8 x 5/8 100	401-257	10 x 2 100	401-433	14 x 1-1/4 100
401-244	8 x 3/4 100	401-422	10 x 2-1/2 50	401-434	14 x 1-1/2 100
401-245	8 x 1 100	403-813	10 x 3 50	401-435	14 x 1-3/4 100
401-246	8 x 1-1/4 100	403-813B	10 x 3-1/2 50	401-436	14 x 2 100
401-247	8 x 1-1/2 100	403-813C	10 x 4 50	401-437	14 x 2-1/2 50
401-247A	8 x 1-3/4 100			401-438	14 x 3 50
				401-438B	14 x 4 50

**VIS À MÉTAL À TÊTE PAN / ÉTOILÉE**
TAPPING SCREWS PAN HEAD / PHILLIPS

ACIER INOXYDABLE / STAINLESS STEEL

**18-8**

NUMÉRO	DIMENSIONBTE	NUMÉRO	DIMENSIONBTE	NUMÉRO	DIMENSIONBTE
403-824	4 x 1/4 100	400-627	8 x 3/4 100	402-312	10 x 2-1/2 50
400-616	4 x 3/8 100	400-628	8 x 1 100	403-835	10 x 3 50
400-618	4 x 1/2 100	400-628A	8 X 7/8 100		
403-825	4 x 5/8 100	400-629	8 x 1-1/4 100	400-636A	12 x 1/2 100
401-800	4 x 3/4 100	400-630	8 x 1-1/2 100	400-636	12 x 3/4 100
401-802	4 x 1 100	402-306	8 x 1-3/4 100	400-637	12 x 1 100
		402-308	8 x 2 100	400-638	12 x 1-1/4 100
403-826	6 x 1/4 100	403-831	8 x 2-1/2 50	400-639	12 x 1-1/2 100
400-621	6 x 3/8 100	403-832	8 x 3 50	400-641	12 x 2 100
400-622	6 x 1/2 100				
403-827	6 x 5/8 100	403-833	10 x 3/8 100	403-836	14 x 1/2 100
400-623	6 x 3/4 100	400-631	10 x 1/2 100	400-642	14 x 3/4 100
400-624	6 x 1 100	403-834	10 x 5/8 100	400-643	14 x 1 100
403-828	6 x 1-1/4 100	400-632	10 x 3/4 100	400-644	14 x 1-1/4 100
403-829	6 x 1-1/2 100	400-632A	10 X 7/8 100	400-645	14 x 1-1/2 100
		400-633	10 x 1 100	403-335	14 x 1-3/4 100
400-625	8 x 3/8 100	400-634	10 x 1-1/4 100	400-646	14 x 2 100
400-626	8 x 1/2 100	400-635	10 x 1-1/2 100	402-314	14 x 2-1/2 50
403-830	8 x 5/8 100	403-332	10 x 1-3/4 100	403-837	14 x 3 50
		402-310	10 x 2 100		

VIS À MÉTAL À TÊTE PAN / CARRÉE
TAPPING SCREWS PAN HEAD / SOCKET

ACIER INOXYDABLE / STAINLESS STEEL

**18-8**

NUMÉRO	DIMENSIONBTE	NUMÉRO	DIMENSIONBTE	NUMÉRO	DIMENSIONBTE
403-838	4 x 3/8 100	401-266	8 x 1-1/4 100	403-844	12 x 1/2 100
403-839	4 x 1/2 100	401-267	8 x 1-1/2 100	401-440	12 x 3/4 100
403-840	4 x 3/4 100	402-336	8 x 1-3/4 100	401-441	12 x 1 100
		401-268	8 x 2 100	401-442	12 x 1-1/4 100
401-258	6 x 3/8 100	401-269	8 x 2-1/2 50	401-443	12 x 1-1/2 100
401-259	6 x 1/2 100	401-270	8 x 3 50	401-444	12 x 2 100
403-841	6 x 5/8 100			401-445	12 x 2-1/2 50
401-260	6 x 3/4 100	401-271	10 x 1/2 100	401-445A	12 x 3 50
401-261	6 x 1 100	401-272	10 x 5/8 100		
401-261A	6 x 1-1/4 100	401-273	10 x 3/4 100	401-446	14 x 3/4 100
401-261B	6 x 1-1/2 100	401-274	10 x 1 100	401-447	14 x 1 100
401-261E	6 x 2 100	401-275	10 x 1-1/4 100	401-448	14 x 1-1/4 100
403-842	8 x 3/8 100	401-276	10 x 1-1/2 100	401-449	14 x 1-1/2 100
401-262	8 x 1/2 100	401-276A	10 x 1-3/4 100	401-450	14 x 1-3/4 100
401-263	8 x 5/8 100	401-277	10 x 2 100	401-451	14 x 2 100
401-264	8 x 3/4 100	401-439	10 x 2-1/2 50	403-845	14 x 2-1/2 50
401-265	8 x 1 100	401-439A	10 x 3 50	401-452	14 x 3 50
		403-843	10 x 3-1/2 50	401-453	14 x 3-1/2 50
				403-846	14 x 4 50

REV0523

**VIS À MÉTAL À TÊTE OVALE / ÉTOILÉE**
TAPPING SCREWS OVAL HEAD / PHILLIPS**18-8**

ACIER INOXYDABLE / STAINLESS STEEL

NUMÉRO	DIMENSIONBTE	NUMÉRO	DIMENSIONBTE	NUMÉRO	DIMENSIONBTE
403-814	4 x 3/8 100	400-607	8 x 1-1/4 100	403-319	12 x 3/4 100
403-815	4 x 1/2 100	400-608	8 x 1-1/2 100	403-320	12 x 1 100
403-815A	4 x 5/8 100	401-462	8 x 1-3/4 100	402-501	12 x 1-1/4 100
403-816	4 x 3/4 100	403-315	8 x 2 100	403-321	12 x 1-1/2 100
403-817	4 x 1 100	403-821	8 x 2-1/2 50	403-322	12 x 2 100
		403-822	8 x 3 50	403-323	12 x 2-1/2 50
400-601	6 x 1/2 100			403-324	12 x 3 50
400-601A	6 x 5/8 100	403-316	10 x 1/2 100		
400-602	6 x 3/4 100	400-609	10 x 3/4 100	403-325	14 x 3/4 100
400-603	6 x 1 100	400-610	10 x 1 100	403-326	14 x 1 100
403-818	6 x 1-1/4 100	400-611	10 x 1-1/4 100	403-327	14 x 1-1/4 100
403-819	6 x 1-1/2 100	400-612	10 x 1-1/2 100	403-328	14 x 1-1/2 100
		403-317	10 x 1-3/4 100	403-329	14 x 1-3/4 100
400-604	8 x 1/2 100	400-613	10 x 2 100	402-503	14 x 2 100
403-820	8 x 5/8 100	403-318	10 x 2-1/2 50	403-330	14 x 2-1/2 50
400-605	8 x 3/4 100	403-823	10 x 3 50	403-331	14 x 3 50
400-606	8 x 1 100			403-331B	14 x 4 50

VIS À MÉTAL À TÊTE TRUSS / ÉTOILÉE
TAPPING SCREWS TRUSS HEAD / PHILLIPS**18-8**

ACIER INOXYDABLE / STAINLESS STEEL

NUMÉRO	DIMENSIONBTE	NUMÉRO	DIMENSIONBTE	NUMÉRO	DIMENSIONBTE
401-830	6 x 3/8 100	401-860	10 x 3/8 100	403-344	12 x 3/4 100
401-832	6 x 1/2 100	401-862	10 x 1/2 100	403-345	12 x 1 100
401-834	6 x 5/8 100	401-864	10 x 5/8 100	403-346	12 x 1-1/4 100
401-836	6 x 3/4 100	401-866	10 x 3/4 100	403-347	12 x 1-1/2 100
401-838	6 x 1 100	401-868	10 x 1 100	403-348	12 x 1-3/4 100
403-336	6 x 1-1/4 100	401-870	10 x 1-1/4 100	403-349	12 x 2 100
403-337	6 x 1-1/2 100	401-872	10 x 1-1/2 100	403-350	12 x 2-1/2 50
		403-853	10 x 1-3/4 100	403-854	12 x 3 50
401-840	8 x 3/8 100	401-874	10 x 2 100		
401-842	8 x 1/2 100	403-342	10 x 2-1/2 50	403-351	14 x 3/4 100
401-844	8 x 5/8 100	403-343	10 x 3 50	403-352	14 x 1 100
401-846	8 x 3/4 100			403-353	14 x 1-1/4 100
401-848	8 x 1 100			403-354	14 x 1-1/2 100
403-338	8 x 1-1/4 100			403-355	14 x 1-3/4 100
403-339	8 x 1-1/2 100			403-356	14 x 2 100
403-340	8 x 1-3/4 100				
403-341	8 x 2 100				

**VIS À MÉTAL À TÊTE HEX.+ RONDELLE**
TAPPING SCREWS HEX. HEAD + WASHER**18-8****FENDUE / SLOT**

ACIER INOXYDABLE / STAINLESS STEEL

NUMÉRO	DIMENSION	BTE	NUMÉRO	DIMENSION	BTE	NUMÉRO	DIMENSION	BTE			
403-400	6 x	3/8	100	403-411	10 x	3/4	100	127-109AI	14 X	1/2	100
403-401	6 x	1/2	100	403-412	10 x	1	100	127-111AI	14 X	5/8	100
403-402	6 x	5/8	100	403-413	10 x	1-1/4	100	127-112AI	14 X	3/4	100
403-403	6 x	1	100	403-414	10 x	1-1/2	100	127-114AI	14 x	1	100
403-404	8 x	3/8	100	403-415	10 x	2	100	127-115AI	14 x	1-1/4	100
403-405	8 x	1/2	100	403-416	10 x	2-1/2	50	127-116AI	14 x	1-1/2	100
403-406	8 x	3/4	100	403-417	10 x	3	50	403-421	14 x	2	100
403-407	8 x	1	100	127-103AI	12 X	1/2	100	403-422	14 x	2-1/2	50
403-408	8 x	1-1/4	100	127-104AI	12 X	5/8	100	403-423	14 x	3	50
403-409	8 x	1-1/2	100	127-105AI	12 x	3/4	100				
403-410	8 x	2	100	127-106AI	12 x	1	100				
130-114AI	10 x	3/8	100	127-107AI	12 x	1-1/4	100				
127-101AI	10 x	1/2	100	127-108AI	12 x	1-1/2	100				
127-102AI	10 x	5/8	100	403-418	12 x	2	100				
				403-419	12 x	2-1/2	50				
				403-420	12 x	3	50				

VIS À MÉTAL AUTO-PERÇANTE À TÊTE HEX.+ RONDELLE
TAPPING SCREWS SELF DRILLING HEX. HEAD + WASHER**410**

ACIER INOXYDABLE / STAINLESS STEEL 410

NUMÉRO	DIMENSION	BTE	NUMÉRO	DIMENSION	BTE	NUMÉRO	DIMENSION	BTE			
125-245AI	6 x	3/8	100	125-263AI	8 x	1-3/4	100	125-123AI	12 x	1-1/4	100
125-246AI	6 x	1/2	100	125-264AI	8 x	2	100	125-124AI	12 x	1-1/2	100
125-247AI	6 x	5/8	100	125-115AI	10 x	1/2	100	125-124AAI	12 x	1-3/4	100
125-248AI	6 x	3/4	100	125-116AI	10 x	5/8	100	125-160AI	12 x	2	100
125-249AI	6 x	1	100	125-117AI	10 x	3/4	100	125-275AI	12 x	2-1/2	50
125-250AI	6 x	1-1/4	100	125-118AI	10 x	1	100	125-276AI	12 x	3	50
125-251AI	6 x	1-1/2	100	125-119AI	10 x	1-1/4	100	125-125AI	14 x	3/4	100
125-261AI	8 x	3/8	100	125-120AI	10 x	1-1/2	100	125-126AI	14 x	1	100
125-110AI	8 x	1/2	100	125-120AAI	10 x	1-3/4	100	125-127AI	14 x	1-1/4	100
125-262AI	8 x	5/8	100	125-150AI	10 x	2	100	125-128AI	14 x	1-1/2	100
125-111AI	8 x	3/4	100	125-270AI	10 x	2-1/2	50	125-130AI	14 x	2	100
125-112AI	8 x	1	100	125-271AI	10 x	3	50	125-159AI	14 X	2-1/2	50
125-113AI	8 x	1-1/4	100	125-121AI	12 x	3/4	100	125-157AI	14 X	3	50
125-114AI	8 x	1-1/2	100	125-122AI	12 x	1	100	125-158AI	14 X	4	50

REV0523



VIS À MÉTAL AUTO-PERÇANTE À TÊTE PLATE / ÉTOILÉE
TAPPING SCREWS SELF DRILLING FLAT HEAD / PHILLIPS

410

ACIER INOXYDABLE / STAINLESS STEEL 410



NUMÉRO	DIMENSION	BTE	NUMÉRO	DIMENSION	BTE	NUMÉRO	DIMENSION	BTE			
403-855	6 x	3/8	100	403-869	10 x	3/8	100	403-883	12 x	1-1/2	100
403-856	6 x	1/2	100	403-870	10 x	1/2	100	403-884	12 x	1-3/4	100
403-857	6 x	5/8	100	403-871	10 x	5/8	100	403-885	12 x	2	100
403-858	6 x	3/4	100	403-872	10 x	3/4	100	403-886	12 x	2-1/2	50
403-859	6 x	1	100	403-873	10 x	1	100	403-887	12 x	3	50
403-860	6 x	1-1/4	100	403-874	10 x	1-1/4	100	403-888	14 x	3/4	100
403-861	6 x	1-1/2	100	403-875	10 x	1-1/2	100	403-889	14 x	1	100
403-862	8 x	3/8	100	403-876	10 x	1-3/4	100	403-890	14 x	1-1/4	100
403-863	8 x	1/2	100	403-877	10 x	2	100	403-891	14 x	1-1/2	100
403-864	8 x	5/8	100	403-878	10 x	2-1/2	50	403-892	14 x	1-3/4	100
403-865	8 x	3/4	100	403-879	10 x	3	50	403-893	14 x	2	100
403-866	8 x	1	100	403-880	12 x	3/4	100	403-894	14 x	2-1/2	50
403-867	8 x	1-1/4	100	403-881	12 x	1	100	403-895	14 x	3	50
403-868	8 x	1-1/2	100	403-882	12 x	1-1/4	100				

VIS À MÉTAL AUTO-PERÇANTE À TÊTE PLATE / CARRÉE
TAPPING SCREWS SELF DRILLING FLAT HEAD / SOCKET

410

ACIER INOXYDABLE / STAINLESS STEEL 410



NUMÉRO	DIMENSION	BTE	NUMÉRO	DIMENSION	BTE	NUMÉRO	DIMENSION	BTE			
403-896	6 x	3/4	100	403-904	10 x	3/4	100	403-914	14 x	3/4	100
403-897	6 x	1	100	403-905	10 x	1	100	403-915	14 x	1	100
403-899	8 x	1/2	100	403-906	10 x	1-1/4	100	403-916	14 x	1-1/4	100
403-900	8 x	3/4	100	403-907	10 x	1-1/2	100	403-917	14 x	1-1/2	100
403-901	8 x	1	100	403-908	10 x	1-3/4	100	403-918	14 x	2	100
403-902	8 x	1-1/4	100	403-909	10 x	2	100				
403-903	8 x	1-1/2	100	403-910	12 x	3/4	100				
				403-911	12 x	1	100				
				403-912	12 x	1-1/4	100				
				403-913	12 x	1-1/2	100				

**VIS À MÉTAL AUTO-PERÇANTE À TÊTE PAN / ÉTOILÉE**
TAPPING SCREWS SELF DRILLING PAN HEAD / PHILLIPS**410**

ACIER INOXYDABLE / STAINLESS STEEL 410



NUMÉRO	DIMENSION	BTE	NUMÉRO	DIMENSION	BTE	NUMÉRO	DIMENSION	BTE			
125-201AI	6 x	3/8	100	403-847	10 x	3/8	100	125-226AI	12 x	1-1/2	100
125-202AI	6 x	1/2	100	125-105AI	10 x	1/2	100	403-850	12 x	1-3/4	100
125-203AI	6 x	5/8	100	125-218AI	10 x	5/8	100	125-227AI	12 x	2	100
125-204AI	6 x	3/4	100	125-106AI	10 x	3/4	100	125-228AI	12 x	2-1/2	50
125-205AI	6 x	1	100	125-107AI	10 x	1	100	125-229AI	12 x	3	50
125-206AI	6 x	1-1/4	100	125-219AI	10 x	1-1/4	100	125-234AI	14 x	3/4	100
125-207AI	6 x	1-1/2	100	125-220AI	10 x	1-1/2	100	125-235AI	14 x	1	100
125-210AI	8 x	3/8	100	403-848	10 x	1-3/4	100	403-851	14 x	1-1/4	100
125-102AI	8 x	1/2	100	125-285AI	10 x	2	100	125-236AI	14 x	1-1/2	100
125-211AI	8 x	5/8	100	125-286AI	10 x	2-1/2	50	403-852	14 x	1-3/4	100
125-103AI	8 x	3/4	100	125-287AI	10 x	3	50	125-237AI	14 x	2	100
125-104AI	8 x	1	100	125-225AI	12 x	3/4	100	125-238AI	14 x	2-1/2	50
125-212AI	8 x	1-1/4	100	125-108AI	12 x	1	100	125-239AI	14 x	3	50
125-213AI	8 x	1-1/2	100	403-849	12 x	1-1/4	100				

VIS À MÉTAL AUTO-PERÇANTE À TÊTE RONDE / CARRÉE
TAPPING SCREWS SELF DRILLING ROUND HEAD / SOCKET**410**

ACIER INOXYDABLE / STAINLESS STEEL 410



NUMÉRO	DIMENSION	BTE	NUMÉRO	DIMENSION	BTE	NUMÉRO	DIMENSION	BTE			
403-919	6 x	3/8	100	403-930	10 x	1/2	100	403-942	14 x	3/4	100
403-920	6 x	1/2	100	403-931	10 x	5/8	100	403-943	14 x	1	100
403-921	6 x	3/4	100	403-932	10 x	3/4	100	403-944	14 x	1-1/4	100
403-922	6 x	1	100	403-933	10 x	1	100	403-945	14 x	1-1/2	100
403-923	8 x	3/8	100	403-934	10 x	1-1/4	100	403-946	14 x	2	100
403-924	8 x	1/2	100	403-935	10 x	1-1/2	100				
403-925	8 x	5/8	100	403-936	10 x	2	100				
403-926	8 x	3/4	100	403-937	12 x	3/4	100				
403-927	8 x	1	100	403-938	12 x	1	100				
403-928	8 x	1-1/4	100	403-939	12 x	1-1/4	100				
403-929	8 x	1-1/2	100	403-940	12 x	1-1/2	100				
				403-941	12 x	2	100				



VIS À 6 PANS CREUX / TÊTE CYLINDRIQUE SOCKET HEAD CAP SREWS

FILET GROS / COARSE THREAD U.N.C. (U.S.S.)
ACIER INOXIDABLE / STAINLESS STEEL 18-8 (304)



18-8

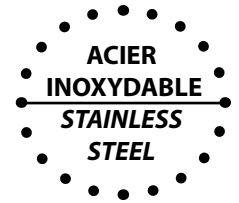

NUMÉRO	DIMENSION	BTE	NUMÉRO	DIMENSION	BTE	NUMÉRO	DIMENSION	BTE
404-010	0-80	x 1/8	404-047	4-40	x 1/8	404-072	8-32	x 3/16
404-011	0-80	x 3/16	404-048	4-40	x 3/16	400-950	8-32	x 1/4
404-012	0-80	x 1/4	400-940	4-40	x 1/4	404-073	8-32	x 5/16
404-013	0-80	x 5/16	404-049	4-40	x 5/16	400-951	8-32	x 3/8
404-014	0-80	x 3/8	400-941	4-40	x 3/8	404-074	8-32	x 7/16
404-015	0-80	x 1/2	404-050	4-40	x 7/16	400-952	8-32	x 1/2
404-016	0-80	x 5/8	400-942	4-40	x 1/2	400-953	8-32	x 5/8
404-017	0-80	x 3/4	404-051	4-40	x 5/8	400-954	8-32	x 3/4
404-018	0-80	x 1	400-943	4-40	x 3/4	404-075	8-32	x 7/8
404-019	1-64	x 1/8	404-052	4-40	x 7/8	400-955	8-32	x 1
404-020	1-64	x 3/16	404-053	4-40	x 1	404-076	8-32	x 1-1/8
404-021	1-64	x 1/4	404-054	4-40	x 1-1/4	400-956	8-32	x 1-1/4
404-022	1-64	x 5/16	404-055	4-40	x 1-1/2	400-957	8-32	x 1-1/2
404-023	1-64	x 3/8	404-056	5-40	x 3/16	404-077	8-32	x 1-3/4
404-024	1-64	x 1/2	332-027Al	5-40	x 1/4	404-078	8-32	x 2
404-025	1-64	x 5/8	404-057	5-40	x 5/16	404-079	8-32	x 2-1/4
404-026	1-64	x 3/4	332-028Al	5-40	x 3/8	404-080	8-32	x 2-1/2
404-027	2-56	x 1/8	332-029Al	5-40	x 1/2	404-081	8-32	x 3
100			332-030Al	5-40	x 5/8	404-082	10-24	x 3/16
404-028	2-56	x 3/16	332-031Al	5-40	x 3/4	404-083	10-24	x 1/4
404-029	2-56	x 1/4	404-058	5-40	x 7/8	404-084	10-24	x 5/16
404-030	2-56	x 5/16	404-059	5-40	x 1	400-958	10-24	x 3/8
404-031	2-56	x 3/8	404-060	6-32	x 3/16	404-085	10-24	x 7/16
404-032	2-56	x 1/2	400-944	6-32	x 1/4	400-959	10-24	x 1/2
404-033	2-56	x 5/8	404-061	6-32	x 5/16	400-960	10-24	x 5/8
404-034	2-56	x 3/4	400-945	6-32	x 3/8	400-961	10-24	x 3/4
404-035	2-56	x 7/8	404-062	6-32	x 7/16	404-086	10-24	x 7/8
404-036	2-56	x 1	400-946	6-32	x 1/2	400-962	10-24	x 1
404-037	3-48	x 1/8	400-947	6-32	x 5/8	404-087	10-24	x 1-1/8
404-038	3-48	x 3/16	400-948	6-32	x 3/4	400-963	10-24	x 1-1/4
404-039	3-48	x 1/4	404-063	6-32	x 7/8	404-088	10-24	x 1-3/8
404-040	3-48	x 3/8	400-949	6-32	x 1	400-964	10-24	x 1-1/2
404-041	3-48	x 3/8	404-064	6-32	x 1-1/8	404-089	10-24	x 1-3/4
404-042	3-48	x 1/2	404-065	6-32	x 1-1/4	404-090	10-24	x 2
404-043	3-48	x 5/8	404-066	6-32	x 1-1/2	404-091	10-24	x 2-1/4
404-044	3-48	x 3/4	404-067	6-32	x 1-3/4	404-092	10-24	x 2-1/2
404-045	3-48	x 7/8	404-068	6-32	x 2	404-093	10-24	x 3
404-046	3-48	x 1	404-069	6-32	x 2-1/4			
			404-070	6-32	x 2-1/2			
			404-071	6-32	x 3			



VIS À 6 PANS CREUX / TÊTE CYLINDRIQUE
SOCKET HEAD CAP SREWS

FILET GROS / COARSE THREAD **U.N.C. (U.S.S.)**
 ACIER INOXIDABLE / STAINLESS STEEL **18-8 (304)**



18-8

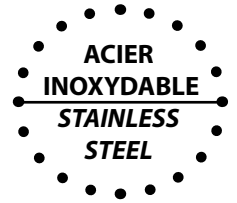

NUMÉRO	DIMENSIONBTE	NUMÉRO	DIMENSIONBTE	NUMÉRO	DIMENSIONBTE
404-094	12-24 x 3/8 100	332-130AI	5/16-18 x 3/8 100	332-200AI	7/16-14 x 1 25
404-095	12-24 x 1/2 100	400-981	5/16-18 x 1/2 100	332-201AI	7/16-14 x 1-1/4 25
404-096	12-24 x 5/8 100	400-982	5/16-18 x 5/8 100	332-203AI	7/16-14 x 1-1/2 25
404-097	12-24 x 3/4 100	400-983	5/16-18 x 3/4 50	332-204AI	7/16-14 x 1-3/4 25
404-098	12-24 x 1 100	400-984	5/16-18 x 7/8 50	332-206AI	7/16-14 x 2 20
404-099	12-24 x 1-1/4 100	400-985	5/16-18 x 1 50	332-207AI	7/16-14 x 2-1/4 20
404-100	12-24 x 1-1/2 100	404-111	5/16-18 x 1-1/8 50	332-209AI	7/16-14 x 2-1/2 20
		400-986	5/16-18 x 1-1/4 50	332-211AI	7/16-14 x 3 10
404-101	1/4-20 x 1/4 100	400-987	5/16-18 x 1-1/2 50		
404-102	1/4-20 x 5/16 100	332-140AI	5/16-18 x 1-3/4 50	332-226AI	1/2-13 x 5/8 25
400-972	1/4-20 x 3/8 100	400-988	5/16-18 x 2 50	401-101	1/2-13 x 3/4 25
404-103	1/4-20 x 7/16 100	332-142AI	5/16-18 x 2-1/4 25	332-229AI	1/2-13 x 7/8 25
400-973	1/4-20 x 1/2 100	332-143AI	5/16-18 x 2-1/2 25	401-102	1/2-13 x 1 25
400-974	1/4-20 x 5/8 100	332-144AI	5/16-18 x 2-3/4 25	401-103	1/2-13 x 1-1/4 25
400-975	1/4-20 x 3/4 100	332-146AI	5/16-18 x 3 25	401-104	1/2-13 x 1-1/2 25
400-976	1/4-20 x 7/8 100	332-147AI	5/16-18 x 3-1/4 25	401-105	1/2-13 x 1-3/4 25
400-977	1/4-20 x 1 100	332-149AI	5/16-18 x 3-1/2 10	401-106	1/2-13 x 2 20
404-104	1/4-20 x 1-1/8 100	404-112	5/16-18 x 4 10	332-237AI	1/2-13 x 2-1/4 20
400-978	1/4-20 x 1-1/4 100	404-113	5/16-18 x 4-1/2 10	401-107	1/2-13 x 2-1/2 20
404-105	1/4-20 x 1-3/8 100	404-114	5/16-18 x 5 10	404-119	1/2-13 x 2-3/4 20
400-979	1/4-20 x 1-1/2 100	404-115	5/16-18 x 6 10	401-108	1/2-13 x 3 10
332-115AI	1/4-20 x 1-3/4 100			332-244AI	1/2-13 x 3-1/2 10
400-980	1/4-20 x 2 100	332-159AI	3/8-16 x 1/2 50	401-109	1/2-13 x 4 10
332-118AI	1/4-20 x 2-1/4 50	332-161AI	3/8-16 x 5/8 50	332-247AI	1/2-13 x 4-1/2 10
332-119AI	1/4-20 x 2-1/2 50	400-989	3/8-16 x 3/4 50	332-248AI	1/2-13 x 5 10
332-120AI	1/4-20 x 2-3/4 50	332-164AI	3/8-16 x 7/8 50	332-251AI	1/2-13 x 6 5
332-122AI	1/4-20 x 3 25	400-990	3/8-16 x 1 50		
404-106	1/4-20 x 3-1/2 25	400-991	3/8-16 x 1-1/4 25	332-261AI	5/8-11 x 1 25
404-107	1/4-20 x 4 25	400-992	3/8-16 x 1-1/2 25	401-110	5/8-11 x 1-1/4 25
404-108	1/4-20 x 4-1/2 10	400-993	3/8-16 x 1-3/4 25	401-111	5/8-11 x 1-1/2 25
404-109	1/4-20 x 5 10	400-994	3/8-16 x 2 25	401-112	5/8-11 x 1-3/4 20
404-110	1/4-20 x 6 10	404-116	3/8-16 x 2-1/4 25	401-113	5/8-11 x 2 20
		400-995	3/8-16 x 2-1/2 25	404-120	5/8-11 x 2-1/4 20
		404-117	3/8-16 x 2-3/4 25	401-114	5/8-11 x 2-1/2 20
		400-996	3/8-16 x 3 10	332-271AI	5/8-11 x 2-3/4 20
		332-177AI	3/8-16 x 3-1/2 10	401-115	5/8-11 x 3 10
		332-178AI	3/8-16 x 4 10	332-275AI	5/8-11 x 3-1/2 10
		332-180AI	3/8-16 x 4-1/2 10	401-116	5/8-11 x 4 10
		332-181AI	3/8-16 x 5 10	332-278AI	5/8-11 x 4-1/2 10
		404-118	3/8-16 x 6 10	332-279AI	5/8-11 x 5 10
				332-280AI	5/8-11 x 5-1/2 10
				332-281AI	5/8-11 x 6 10

VIS À 6 PANS CREUX / TÊTE CYLINDRIQUE
SOCKET HEAD CAP SCREWS

FILET GROS / COARSE THREAD **U.N.C. (U.S.S.)**
 ACIER INOXIDABLE / STAINLESS STEEL **18-8 (304)**



18-8

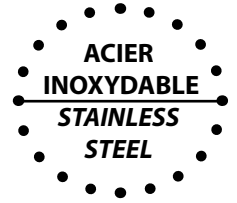

NUMÉRO	DIMENSIONBTE	NUMÉRO	DIMENSIONBTE	NUMÉRO	DIMENSIONBTE
332-295AI	3/4-10 x 1-1/4 20	332-324AI	7/8-9 x 2 10	332-351AI	1-8 x 2 10
401-117	3/4-10 x 1-1/2 20	332-326AI	7/8-9 x 2-1/4 10	332-352AI	1-8 x 2-1/4 10
401-118	3/4-10 x 1-3/4 20	332-327AI	7/8-9 x 2-1/2 10	332-353AI	1-8 x 2-1/2 10
401-119	3/4-10 x 2 20	332-329AI	7/8-9 x 2-3/4 10	332-355AI	1-8 x 2-3/4 10
332-300AI	3/4-10 x 2-1/4 20	332-330AI	7/8-9 x 3 10	332-356AI	1-8 x 3 10
401-120	3/4-10 x 2-1/2 20	332-333AI	7/8-9 x 3-1/2 10	332-359AI	1-8 x 3-1/2 10
332-303AI	3/4-10 x 2-3/4 20	332-334AI	7/8-9 x 4 5	332-360AI	1-8 x 4 5
401-121	3/4-10 x 3 10	332-335AI	7/8-9 x 4-1/2 5	332-362AI	1-8 x 4-1/2 5
332-307AI	3/4-10 x 3-1/2 10	332-337AI	7/8-9 x 5 5	332-363AI	1-8 x 5 5
401-122	3/4-10 x 4 10	332-339AI	7/8-9 x 6 5	332-365AI	1-8 x 6 5
332-310AI	3/4-10 x 4-1/2 10	332-341AI	7/8-9 x 6-1/2 1	332-367AI	1-8 x 6-1/2 1
332-311AI	3/4-10 x 5 10	332-342AI	7/8-9 x 7 1	332-369AI	1-8 x 7 1
332-314AI	3/4-10 x 6 10	332-344AI	7/8-9 x 8 1	332-370AI	1-8 x 8 1
332-315AI	3/4-10 x 6-1/2 5				
332-316AI	3/4-10 x 7 5				
332-317AI	3/4-10 x 8 5				



VIS À 6 PANS CREUX / TÊTE CYLINDRIQUE
SOCKET HEAD CAP SREWS

FILET FIN / FINE THREAD U.N.F. (S.A.E.)

ACIER INOXYDABLE / STAINLESS STEEL 18-8 (304)



18-8

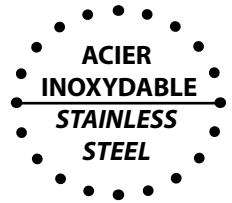

NUMÉRO	DIMENSION	BTE	NUMÉRO	DIMENSION	BTE	NUMÉRO	DIMENSION	BTE			
404-121	1-72	x 1/8	100	404-162	6-40	x 5/8	100	332-474AI	5/16-24	x 3/8	100
404-122	1-72	x 3/16	100	404-163	6-40	x 3/4	100	332-475AI	5/16-24	x 1/2	100
404-123	1-72	x 1/4	100	404-164	6-40	x 1	100	332-476AI	5/16-24	x 5/8	100
404-124	1-72	x 5/16	100					332-477AI	5/16-24	x 3/4	50
404-125	1-72	x 3/8	100	404-165	8-36	x 1/4	100	332-479AI	5/16-24	x 7/8	50
404-126	1-72	x 1/2	100	404-166	8-36	x 3/8	100	332-480AI	5/16-24	x 1	50
404-127	1-72	x 5/8	100	404-167	8-36	x 1/2	100	332-482AI	5/16-24	x 1-1/4	50
404-128	1-72	x 3/4	100	404-168	8-36	x 5/8	100	332-483AI	5/16-24	x 1-1/2	50
404-129	1-72	x 1	100	404-169	8-36	x 3/4	100	332-484AI	5/16-24	x 1-3/4	50
				404-170	8-36	x 1	100	332-485AI	5/16-24	x 2	50
404-130	2-64	x 3/16	100					332-487AI	5/16-24	x 2-1/4	25
404-131	2-64	x 1/4	100	404-171	10-32	x 3/16	100	332-488AI	5/16-24	x 2-1/2	25
404-132	2-64	x 5/16	100	404-172	10-32	x 1/4	100	332-489AI	5/16-24	x 2-3/4	25
404-133	2-64	x 3/8	100	404-173	10-32	x 5/16	100	332-491AI	5/16-24	x 3	25
404-134	2-64	x 1/2	100	400-965	10-32	x 3/8	100				
404-135	2-64	x 5/8	100	404-174	10-32	x 7/16	100	332-501AI	3/8-24	x 1/2	50
404-136	2-64	x 3/4	100	400-966	10-32	x 1/2	100	332-502AI	3/8-24	x 5/8	50
				400-967	10-32	x 5/8	100	332-503AI	3/8-24	x 3/4	50
404-137	3-56	x 3/16	100	400-968	10-32	x 3/4	100	332-504AI	3/8-24	x 7/8	50
404-138	3-56	x 1/4	100	404-175	10-32	x 7/8	100	332-506AI	3/8-24	x 1	50
404-139	3-56	x 3/8	100	400-969	10-32	x 1	100	332-507AI	3/8-24	x 1-1/4	25
404-140	3-56	x 1/2	100	404-176	10-32	x 1-1/8	100	332-509AI	3/8-24	x 1-1/2	25
404-141	3-56	x 5/8	100	400-970	10-32	x 1-1/4	100	332-510AI	3/8-24	x 1-3/4	25
404-142	3-56	x 3/4	100	404-177	10-32	x 1-3/8	100	332-511AI	3/8-24	x 2	25
404-143	3-56	x 1	100	400-971	10-32	x 1-1/2	100	332-512AI	3/8-24	x 2-1/4	25
				404-178	10-32	x 1-3/4	50	332-514AI	3/8-24	x 2-1/2	25
404-144	4-48	x 3/16	100	404-179	10-32	x 2	50	404-184	3/8-24	x 2-3/4	25
404-145	4-48	x 1/4	100	404-180	10-32	x 2-1/4	25	332-516AI	3/8-24	x 3	10
404-146	4-48	x 3/8	100	404-181	10-32	x 2-1/2	25				
404-147	4-48	x 1/2	100	404-182	10-32	x 3	25	332-536AI	7/16-20	x 1	100
404-148	4-48	x 5/8	100					332-537AI	7/16-20	x 1-1/4	100
404-149	4-48	x 3/4	100	332-450AI	1/4-28	x 3/8	100	332-538AI	7/16-20	x 1-1/2	100
404-150	4-48	x 1	100	332-451AI	1/4-28	x 1/2	100				
				332-452AI	1/4-28	x 5/8	100	332-560AI	1/2-20	x 3/4	25
404-151	5-44	x 1/4	100	332-454AI	1/4-28	x 3/4	100	332-562AI	1/2-20	x 1	25
404-152	5-44	x 5/16	100	332-455AI	1/4-28	x 7/8	100	332-564AI	1/2-20	x 1-1/4	25
404-153	5-44	x 3/8	100	332-456AI	1/4-28	x 1	100	332-565AI	1/2-20	x 1-1/2	25
404-154	5-44	x 1/2	100	332-458AI	1/4-28	x 1-1/4	100	332-566AI	1/2-20	x 1-3/4	25
404-155	5-44	x 5/8	100	332-459AI	1/4-28	x 1-1/2	100	332-567AI	1/2-20	x 2	20
404-156	5-44	x 3/4	100	332-460AI	1/4-28	x 1-3/4	100	332-568AI	1/2-20	x 2-1/4	20
404-157	5-44	x 1	100	332-462AI	1/4-28	x 2	100	332-570AI	1/2-20	x 2-1/2	20
				332-463AI	1/4-28	x 2-1/4	50	332-573AI	1/2-20	x 3	10
404-158	6-40	x 1/4	100	332-464AI	1/4-28	x 2-1/2	50				
404-159	6-40	x 5/16	100	332-466AI	1/4-28	x 2-3/4	50				
404-160	6-40	x 3/8	100	332-467AI	1/4-28	x 3	25				
404-161	6-40	x 1/2	100								

REV0523

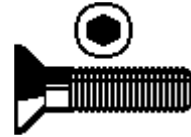
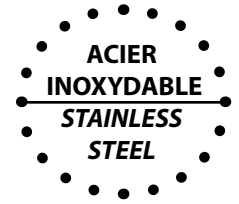

VIS À 6 PANS CREUX / TÊTE FRAISÉE
SOCKET HEAD CAP SCREWS / FLAT HEAD

**18-8**FILET GROS / COARSE THREAD **U.N.C. (U.S.S.)**ACIER INOXYDABLE / STAINLESS STEEL **18-8 (304)**

NUMÉRO	DIMENSION	BTE	NUMÉRO	DIMENSION	BTE	NUMÉRO	DIMENSION	BTE			
404-185	0-80	x 1/8	100	338-126Al	6-32	x 1/4	100	404-228	5/16-18	x 3/8	100
404-186	0-80	x 3/16	100	404-214	6-32	x 5/16	100	338-188Al	5/16-18	x 1/2	100
404-187	0-80	x 1/4	100	338-127Al	6-32	x 3/8	100	338-190Al	5/16-18	x 5/8	100
404-188	0-80	x 5/16	100	401-123	6-32	x 1/2	100	401-137	5/16-18	x 3/4	50
404-189	0-80	x 3/8	100	338-131Al	6-32	x 5/8	100	404-229	5/16-18	x 7/8	50
404-190	0-80	x 1/2	100	338-132Al	6-32	x 3/4	100	401-138	5/16-18	x 1	50
404-191	1-72	x 1/8	100	404-215	6-32	x 7/8	100	401-139	5/16-18	x 1-1/4	50
404-192	1-72	x 3/16	100	404-216	6-32	x 1	100	401-140	5/16-18	x 1-1/2	50
404-193	1-72	x 1/4	100	404-217	6-32	x 1-1/4	100	338-196Al	5/16-18	x 1-3/4	50
404-194	1-72	x 5/16	100	404-218	6-32	x 1-1/2	100	338-197Al	5/16-18	x 2	50
404-195	1-72	x 3/8	100	404-219	8-32	x 1/4	100	338-199Al	5/16-18	x 2-1/4	25
404-196	1-72	x 1/2	100	404-220	8-32	x 5/16	100	338-200Al	5/16-18	x 2-1/2	25
404-197	2-56	x 3/16	100	338-139Al	8-32	x 3/8	100	404-230	5/16-18	x 3	25
404-198	2-56	x 1/4	100	401-124	8-32	x 1/2	100	338-208Al	3/8-16	x 1/2	50
404-200	2-56	x 5/16	100	338-141Al	8-32	x 5/8	100	338-209Al	3/8-16	x 5/8	50
404-201	2-56	x 3/8	100	338-143Al	8-32	x 3/4	100	401-141	3/8-16	x 3/4	50
404-202	2-56	x 1/2	100	404-221	8-32	x 7/8	100	404-231	3/8-16	x 7/8	50
404-203	2-56	x 5/8	100	338-144Al	8-32	x 1	100	401-142	3/8-16	x 1	50
404-204	2-56	x 3/4	100	404-222	8-32	x 1-1/4	100	401-143	3/8-16	x 1-1/4	25
404-205	3-48	x 1/4	100	404-223	8-32	x 1-1/2	100	401-144	3/8-16	x 1-1/2	25
404-206	3-48	x 5/16	100	404-224	10-24	x 5/16	100	401-144A	3/8-16	x 1-3/4	25
404-207	3-48	x 3/8	100	338-150Al	10-24	x 3/8	100	338-217Al	3/8-16	x 2	25
404-208	3-48	x 1/2	100	404-225	10-24	x 7/16	100	338-218Al	3/8-16	x 2-1/4	25
404-209	3-48	x 5/8	100	401-128	10-24	x 1/2	100	338-220Al	3/8-16	x 2-1/2	25
404-210	3-48	x 3/4	100	401-129	10-24	x 5/8	100	338-221Al	3/8-16	x 3	10
338-101Al	4-40	x 1/4	100	401-130	10-24	x 3/4	100	338-245Al	1/2-13	x 3/4	25
404-211	4-40	x 5/16	100	404-226	10-24	x 7/8	100	404-232	1/2-13	x 7/8	25
338-102Al	4-40	x 3/8	100	338-156Al	10-24	x 1	100	338-246Al	1/2-13	x 1	25
338-104Al	4-40	x 1/2	100	338-157Al	10-24	x 1-1/4	100	338-247Al	1/2-13	x 1-1/4	25
338-105Al	4-40	x 5/8	100	338-158Al	10-24	x 1-1/2	100	338-249Al	1/2-13	x 1-1/2	25
338-105Al	4-40	x 3/4	100	338-164Al	1/4-20	x 3/8	100	338-250Al	1/2-13	x 1-3/4	25
404-212	4-40	x 1	100	401-131	1/4-20	x 1/2	100	338-251Al	1/2-13	x 2	25
338-115Al	5-40	x 1/4	100	401-132	1/4-20	x 5/8	100	338-252Al	1/2-13	x 2-1/4	25
338-116Al	5-40	x 3/8	100	401-133	1/4-20	x 3/4	100	338-253Al	1/2-13	x 2-1/2	25
338-118Al	5-40	x 1/2	100	404-227	1/4-20	x 7/8	100	338-255Al	1/2-13	x 3	10
338-119Al	5-40	x 5/8	100	401-134	1/4-20	x 1	100	404-233	1/2-13	x 3-1/2	10
338-120Al	5-40	x 3/4	100	401-135	1/4-20	x 1-1/4	100	404-234	1/2-13	x 4	10
404-213	5-40	x 1	100	401-136	1/4-20	x 1-1/2	100				
				338-173Al	1/4-20	x 1-3/4	100				
				338-175Al	1/4-20	x 2	100				

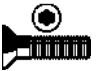

VIS À 6 PANS CREUX / TÊTE FRAISÉE
SOCKET HEAD CAP SCREWS / FLAT HEAD

FILET GROS / COARSE THREAD **U.N.C. (U.S.S.)**
 ACIER INOXYDABLE / STAINLESS STEEL **18-8 (304)**



18-8

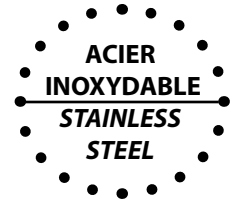

NUMÉRO	DIMENSIONBTE	NUMÉRO	DIMENSIONBTE	
404-235	5/8-11 x 1 25	338-276AI	3/4-10 x 1-1/4 20	U.N.C. (U.S.S.)
338-262AI	5/8-11 x 1-1/4 25	338-278AI	3/4-10 x 1-1/2 20	
338-263AI	5/8-11 x 1-1/2 25	338-279AI	3/4-10 x 1-3/4 20	
338-265AI	5/8-11 x 1-3/4 20	338-281AI	3/4-10 x 2 20	
338-266AI	5/8-11 x 2 20	338-284AI	3/4-10 x 2-1/2 20	
338-267AI	5/8-11 x 2-1/4 20	338-285AI	3/4-10 x 3 10	
338-268AI	5/8-11 x 2-1/2 20	404-238	3/4-10 x 3-1/2 10	
338-270AI	5/8-11 x 3 10	404-239	3/4-10 x 4 10	
404-236	5/8-11 x 3-1/2 10			
404-237	5/8-11 x 4 10			

VIS À 6 PANS CREUX / TÊTE FRAISÉE
SOCKET HEAD CAP SCREWS / FLAT HEAD

FILET FIN / FINE THREAD **U.N.F. (S.A.E.)**
 ACIER INOXYDABLE / STAINLESS STEEL **18-8 (304)**

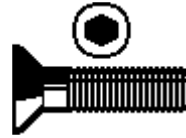

18-8

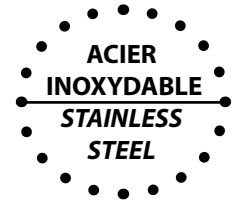

NUMÉRO	DIMENSIONBTE	NUMÉRO	DIMENSIONBTE	
404-240	10-32 x 5/16 100	404-249	1/4-28 x 3/8 100	U.N.F. (S.A.E.)
404-241	10-32 x 3/8 100	404-250	1/4-28 x 1/2 100	
404-242	10-32 x 7/16 100	404-251	1/4-28 x 5/8 100	
401-125	10-32 x 1/2 100	404-252	1/4-28 x 3/4 100	
401-126	10-32 x 5/8 100	404-253	1/4-28 x 7/8 100	
401-127	10-32 x 3/4 100	404-254	1/4-28 x 1 100	
404-243	10-32 x 7/8 100	404-255	1/4-28 x 1-1/4 100	
404-244	10-32 x 1 100	404-256	1/4-28 x 1-1/2 100	
404-245	10-32 x 1-1/4 100	404-257	1/4-28 x 2 100	
404-246	10-32 x 1-1/2 100			
404-247	10-32 x 1-3/4 100			
404-248	10-32 x 2 100			



VIS DE PRESSION À 6 PANS CREUX / POINTE CUVETTE
SET SCREWS HEX SOCKET / CUP POINT

FILET GROS / COARSE THREAD U.N.C. (U.S.S.)

ACIER INOXYDABLE / STAINLESS STEEL 18-8 (304)

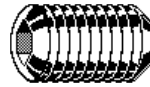

18-8

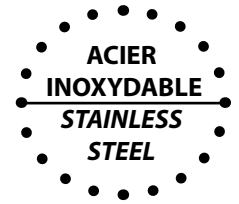

NUMÉRO	DIMENSION	BTE	NUMÉRO	DIMENSION	BTE	NUMÉRO	DIMENSION	BTE
404-369	0-80 x 1/16	100	404-408	5-40 x 1/8	100	404-435	10-24 x 1	100
404-370	0-80 x 3/32	100	404-409	5-40 x 3/16	100	404-436	10-24 x 1-1/4	100
404-371	0-80 x 1/8	100	404-410	5-40 x 1/4	100	400-910	1/4-20 x 3/16	100
404-372	0-80 x 3/16	100	404-411	5-40 x 5/16	100	400-911	1/4-20 x 1/4	100
404-373	0-80 x 1/4	100	404-412	5-40 x 3/8	100	400-912	1/4-20 x 5/16	100
404-374	0-80 x 5/16	100	404-413	5-40 x 1/2	100	400-913	1/4-20 x 3/8	100
404-375	0-80 x 3/8	100	404-414	5-40 x 3/4	100	400-914	1/4-20 x 1/2	100
404-376	1-72 x 1/16	100	404-415	5-40 x 1	100	400-915	1/4-20 x 5/8	100
404-377	1-72 x 3/32	100	404-416	6-32 x 3/32	100	400-916	1/4-20 x 3/4	100
404-378	1-72 x 1/8	100	400-890	6-32 x 1/8	100	404-437	1/4-20 x 7/8	100
404-379	1-64 x 3/16	100	400-891	6-32 x 3/16	100	400-917	1/4-20 x 1	100
404-380	1-64 x 1/4	100	400-892	6-32 x 1/4	100	404-438	1/4-20 x 1-1/4	100
404-381	1-64 x 5/16	100	404-417	6-32 x 5/16	100	404-439	1/4-20 x 1-1/2	100
404-382	1-64 x 3/8	100	400-893	6-32 x 3/8	100	404-440	1/4-20 x 1-3/4	50
404-383	2-56 x 1/16	100	404-418	6-32 x 7/16	100	404-441	1/4-20 x 2	50
404-384	2-56 x 3/32	100	400-894	6-32 x 1/2	100	400-920	5/16-18 x 1/4	50
404-385	2-56 x 1/8	100	404-419	6-32 x 5/8	100	400-921	5/16-18 x 5/16	50
404-386	2-56 x 3/16	100	404-420	6-32 x 3/4	100	400-922	5/16-18 x 3/8	50
404-387	2-56 x 1/4	100	404-421	6-32 x 1	100	404-442	5/16-18 x 7/16	50
404-388	2-56 x 5/16	100	400-895	8-32 x 1/8	100	400-923	5/16-18 x 1/2	50
404-389	2-56 x 3/8	100	400-896	8-32 x 3/16	100	400-924	5/16-18 x 5/8	50
404-390	2-56 x 1/2	100	400-897	8-32 x 1/4	100	400-925	5/16-18 x 3/4	50
404-391	2-56 x 5/8	100	404-422	8-32 x 5/16	100	404-443	5/16-18 x 7/8	50
404-392	2-56 x 3/4	100	400-898	8-32 x 3/8	100	400-926	5/16-18 x 1	50
404-393	3-48 x 1/16	100	404-423	8-32 x 7/16	100	404-444	5/16-18 x 1-1/4	50
404-394	3-48 x 3/32	100	400-899	8-32 x 1/2	100	404-445	5/16-18 x 1-1/2	50
404-395	3-48 x 1/8	100	404-424	8-32 x 5/8	100	404-446	5/16-18 x 1-3/4	25
404-396	3-48 x 3/16	100	404-425	8-32 x 3/4	100	404-447	5/16-18 x 2	25
404-397	3-48 x 1/4	100	404-426	8-32 x 7/8	100	404-448	3/8-16 x 1/4	50
404-398	3-48 x 5/16	100	404-427	8-32 x 1	100	404-449	3/8-16 x 5/16	50
404-399	3-48 x 3/8	100	404-428	8-32 x 1-1/4	100	401-227	3/8-16 x 3/8	50
404-400	4-40 x 3/32	100	404-429	8-32 x 1-1/2	100	404-450	3/8-16 x 7/16	50
404-401	4-40 x 1/8	100	404-430	10-24 x 1/8	100	401-228	3/8-16 x 1/2	50
404-402	4-40 x 3/16	100	400-900	10-24 x 3/16	100	401-229	3/8-16 x 5/8	50
405-586	4-40 x 1/4	100	400-901	10-24 x 1/4	100	401-230	3/8-16 x 3/4	50
404-403	4-40 x 5/16	100	404-431	10-24 x 5/16	100	404-451	3/8-16 x 7/8	50
405-587	4-40 x 3/8	100	400-902	10-24 x 3/8	100	401-231	3/8-16 x 1	50
404-404	4-40 x 1/2	100	404-432	10-24 x 7/16	100	401-232	3/8-16 x 1-1/4	50
404-405	4-40 x 5/8	100	400-903	10-24 x 1/2	100	404-452	3/8-16 x 1-1/2	50
404-406	4-40 x 3/4	100	404-433	10-24 x 5/8	100	404-453	3/8-16 x 1-3/4	25
404-407	4-40 x 1	100	400-904	10-24 x 3/4	100	404-454	3/8-16 x 2	25
			404-434	10-24 x 7/8	100			

REV0523

**VIS DE PRESSION À 6 PANS CREUX / POINTE CUVETTE**
SOCKET SET SCREWS / CUP POINT

FILET GROS / COARSE THREAD U.N.C. (U.S.S.)

ACIER INOXYDABLE / STAINLESS STEEL 18-8 (304)

**18-8**

NUMÉRO	DIMENSIONBTE				NUMÉRO	DIMENSIONBTE				NUMÉRO	DIMENSIONBTE			
404-455	7/16-14	x	1/2	25	404-464	1/2-13	x	1-1/4	25	404-472	3/4-10	x	3/4	20
404-456	7/16-14	x	5/8	25	401-237	1/2-13	x	1-1/2	25	404-473	3/4-10	x	1	20
404-457	7/16-14	x	3/4	25	404-465	1/2-13	x	1-3/4	25	404-474	3/4-10	x	1-1/4	20
404-458	7/16-14	x	1	25	404-466	1/2-13	x	2	25	404-475	3/4-10	x	1-1/2	20
404-459	7/16-14	x	1-1/4	25	404-467	5/8-11	x	1/2	25	404-476	3/4-10	x	1-3/4	20
404-460	7/16-14	x	1-1/2	25	404-468	5/8-11	x	5/8	25	404-477	3/4-10	x	2	20
404-461	1/2-13	x	3/8	25	400-937	5/8-11	x	3/4	25	404-478	1-8	x	1	10
401-234	1/2-13	x	1/2	25	400-938	5/8-11	x	1	25	404-479	1-8	x	1-1/4	10
404-462	1/2-13	x	5/8	25	404-469	5/8-11	x	1-1/4	25	404-480	1-8	x	1-1/2	10
401-235	1/2-13	x	3/4	25	400-939	5/8-11	x	1-1/2	25	404-481	1-8	x	1-3/4	10
404-463	1/2-13	x	7/8	25	404-470	5/8-11	x	1-3/4	25	404-482	1-8	x	2	10
401-236	1/2-13	x	1	25	404-471	5/8-11	x	2	25	404-483	1-8	x	2-1/2	10
										404-484	1-8	x	3	10

VIS DE PRESSION À 6 PANS CREUX / POINTE CUVETTE
SOCKET SET SCREWS / CUP POINT

FILET FIN / FINE THREAD U.N.F. (S.A.E.)

ACIER INOXYDABLE / STAINLESS STEEL 18-8 (304)

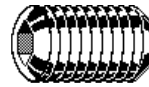
**18-8**

NUMÉRO	DIMENSIONBTE				NUMÉRO	DIMENSIONBTE				NUMÉRO	DIMENSIONBTE			
404-485	10-32	x	1/8	100	404-495	1/4-28	x	7/16	100	404-513	3/8-24	x	1/4	25
400-905	10-32	x	3/16	100	404-496	1/4-28	x	1/2	100	404-514	3/8-24	x	5/16	25
400-906	10-32	x	1/4	100	404-497	1/4-28	x	5/8	100	404-515	3/8-24	x	3/8	25
404-486	10-32	x	5/16	100	404-498	1/4-28	x	3/4	100	404-516	3/8-24	x	1/2	25
400-907	10-32	x	3/8	100	404-499	1/4-28	x	7/8	100	404-517	3/8-24	x	5/8	25
404-487	10-32	x	7/16	100	404-500	1/4-28	x	1	100	404-518	3/8-24	x	3/4	25
400-908	10-32	x	1/2	100	404-501	1/4-28	x	1-1/4	100	404-519	3/8-24	x	1	25
404-488	10-32	x	5/8	100	404-502	1/4-28	x	1-1/2	100	404-520	3/8-24	x	1-1/4	25
400-909	10-32	x	3/4	100	404-503	1/4-28	x	1-3/4	50	404-521	3/8-24	x	1-1/2	25
404-489	10-32	x	7/8	100	404-504	1/4-28	x	2	50					
404-490	10-32	x	1	100						404-522	7/16-20	x	1/2	25
404-491	10-32	x	1-1/4	100	404-505	5/16-24	x	1/4	50	404-523	7/16-20	x	5/8	25
404-492	10-32	x	1-1/2	100	404-506	5/16-24	x	5/16	50	404-524	7/16-20	x	3/4	25
					404-507	5/16-24	x	3/8	50	404-525	7/16-20	x	1	25
400-918	1/4-28	x	3/16	100	404-508	5/16-24	x	1/2	50					
400-919	1/4-28	x	1/4	100	404-509	5/16-24	x	5/8	50	404-526	1/2-20	x	1/2	25
404-493	1/4-28	x	5/16	100	404-510	5/16-24	x	3/4	50	404-527	1/2-20	x	5/8	25
404-494	1/4-28	x	3/8	100	404-511	5/16-24	x	1	50	404-528	1/2-20	x	3/4	25
					404-512	5/16-24	x	1-1/4	50	404-529	1/2-20	x	1	25

**VIS DE PRESSION À 6 PANS CREUX / POINTE PLATE**
SOCKET SET SCREWS / FLAT POINT**18-8**

FILET GROS / COARSE THREAD U.N.C. (U.S.S.)

ACIER INOXYDABLE / STAINLESS STEEL 18-8 (304)

NUMÉRO	DIMENSION	BTE	NUMÉRO	DIMENSION	BTE	NUMÉRO	DIMENSION	BTE
404-530	4-40 x 1/8	100	404-543	10-24 x 3/16	100	404-557	5/16-18 x 1/2	50
404-531	4-40 x 3/16	100	404-544	10-24 x 1/4	100	404-558	5/16-18 x 3/4	50
404-532	4-40 x 1/4	100	404-545	10-24 x 5/16	100	404-559	5/16-18 x 1	50
404-533	6-32 x 1/8	100	404-546	10-24 x 3/8	100	404-560	3/8-16 x 3/8	25
404-534	6-32 x 3/16	100	404-547	10-24 x 1/2	100	404-561	3/8-16 x 1/2	25
404-535	6-32 x 1/4	100	404-548	1/4-20 x 1/4	100	404-562	3/8-16 x 5/8	25
404-536	6-32 x 5/16	100	404-549	1/4-20 x 5/16	100	404-563	3/8-16 x 3/4	25
404-537	6-32 x 3/8	100	404-550	1/4-20 x 3/8	100	404-564	3/8-16 x 1	25
404-538	8-32 x 1/8	100	404-551	1/4-20 x 1/2	100	FILET FIN / FINE THREAD U.N.F. (S.A.E.)		
404-539	8-32 x 3/16	100	404-552	1/4-20 x 5/8	100	404-565	10-32 x 3/16	100
404-540	8-32 x 1/4	100	404-553	1/4-20 x 3/4	100	404-566	10-32 x 1/4	100
404-541	8-32 x 5/16	100	404-554	1/4-20 x 1	100	404-567	10-32 x 5/16	100
404-542	8-32 x 3/8	100	404-555	5/16-18 x 5/16	50	404-568	10-32 x 3/8	100
			404-556	5/16-18 x 3/8	50	404-569	10-32 x 1/2	100

VIS DE PRESSION À 6 PANS CREUX / POINTE CONIQUE
SOCKET SET SCREWS / CONE POINT**18-8**

FILET GROS / COARSE THREAD U.N.C. (U.S.S.)

ACIER INOXYDABLE / STAINLESS STEEL 18-8 (304)

NUMÉRO	DIMENSION	BTE	NUMÉRO	DIMENSION	BTE	NUMÉRO	DIMENSION	BTE
404-570	4-40 x 1/8	100	404-583	10-24 x 3/16	100	404-597	5/16-18 x 1/2	50
404-571	4-40 x 3/16	100	404-584	10-24 x 1/4	100	404-598	5/16-18 x 3/4	50
404-572	4-40 x 1/4	100	404-585	10-24 x 5/16	100	404-599	5/16-18 x 1	50
404-573	6-32 x 1/8	100	404-586	10-24 x 3/8	100	404-600	3/8-16 x 3/8	25
404-574	6-32 x 3/16	100	404-587	10-24 x 1/2	100	404-601	3/8-16 x 1/2	25
404-575	6-32 x 1/4	100	404-588	1/4-20 x 1/4	100	404-602	3/8-16 x 5/8	25
404-576	6-32 x 5/16	100	404-589	1/4-20 x 5/16	100	404-603	3/8-16 x 3/4	25
404-577	6-32 x 3/8	100	404-590	1/4-20 x 3/8	100	404-604	3/8-16 x 1	25
404-578	8-32 x 1/8	100	404-591	1/4-20 x 1/2	100	FILET FIN / FINE THREAD U.N.F. (S.A.E.)		
404-579	8-32 x 3/16	100	404-592	1/4-20 x 5/8	100	404-605	10-32 x 3/16	100
404-580	8-32 x 1/4	100	404-593	1/4-20 x 3/4	100	404-606	10-32 x 1/4	100
404-581	8-32 x 5/16	100	404-594	1/4-20 x 1	100	404-607	10-32 x 5/16	100
404-582	8-32 x 3/8	100	404-595	5/16-18 x 5/16	50	404-608	10-32 x 3/8	100
			404-596	5/16-18 x 3/8	50	404-609	10-32 x 1/2	100
						404-609A	10-32 x 5/8	100



VIS DE PRESSION À 6 PANS CREUX / POINTE OVALE
SOCKET SET SCREWS / OVAL POINT

FILET GROS / COARSE THREAD U.N.C. (U.S.S.)

ACIER INOXYDABLE / STAINLESS STEEL 18-8 (304)

**18-8**

NUMÉRO	DIMENSION	BTE	NUMÉRO	DIMENSION	BTE	NUMÉRO	DIMENSION	BTE
404-610	4-40 x 1/8	100	404-623	10-24 x 3/16	100	404-637	5/16-18 x 1/2	50
404-611	4-40 x 3/16	100	404-624	10-24 x 1/4	100	404-638	5/16-18 x 3/4	50
404-612	4-40 x 1/4	100	404-625	10-24 x 5/16	100	404-639	5/16-18 x 1	50
404-613	6-32 x 1/8	100	404-626	10-24 x 3/8	100	404-640	3/8-16 x 3/8	25
404-614	6-32 x 3/16	100	404-627	10-24 x 1/2	100	404-641	3/8-16 x 1/2	25
404-615	6-32 x 1/4	100	404-628	1/4-20 x 1/4	100	404-642	3/8-16 x 5/8	25
404-616	6-32 x 5/16	100	404-629	1/4-20 x 5/16	100	404-643	3/8-16 x 3/4	25
404-617	6-32 x 3/8	100	404-630	1/4-20 x 3/8	100	404-644	3/8-16 x 1	25
404-618	8-32 x 1/8	100	404-631	1/4-20 x 1/2	100	FILET FIN / FINE THREAD U.N.F. (S.A.E.)		
404-619	8-32 x 3/16	100	404-632	1/4-20 x 5/8	100	404-645	10-32 x 3/16	100
404-620	8-32 x 1/4	100	404-633	1/4-20 x 3/4	100	404-646	10-32 x 1/4	100
404-621	8-32 x 5/16	100	404-634	1/4-20 x 1	100	404-647	10-32 x 5/16	100
404-622	8-32 x 3/8	100	404-635	5/16-18 x 5/16	50	404-648	10-32 x 3/8	100
			404-636	5/16-18 x 3/8	50	404-649	10-32 x 1/2	100

VIS DE PRESSION À 6 PANS CREUX / POINTE DEMI-TETON
SOCKET SET SCREWS / HALF DOG POINT

FILET GROS / COARSE THREAD U.N.C. (U.S.S.)

ACIER INOXYDABLE / STAINLESS STEEL 18-8 (304)

**18-8**

NUMÉRO	DIMENSION	BTE	NUMÉRO	DIMENSION	BTE	NUMÉRO	DIMENSION	BTE
404-650	4-40 x 1/8	100	404-663	10-24 x 3/16	100	404-677	5/16-18 x 1/2	50
404-651	4-40 x 3/16	100	404-664	10-24 x 1/4	100	404-678	5/16-18 x 3/4	50
404-652	4-40 x 1/4	100	404-665	10-24 x 5/16	100	404-679	5/16-18 x 1	50
404-653	6-32 x 1/8	100	404-666	10-24 x 3/8	100	404-680	3/8-16 x 3/8	25
404-654	6-32 x 3/16	100	404-667	10-24 x 1/2	100	404-681	3/8-16 x 1/2	25
404-655	6-32 x 1/4	100	404-668	1/4-20 x 1/4	100	404-682	3/8-16 x 5/8	25
404-656	6-32 x 5/16	100	404-669	1/4-20 x 5/16	100	404-683	3/8-16 x 3/4	25
404-657	6-32 x 3/8	100	404-670	1/4-20 x 3/8	100	404-684	3/8-16 x 1	25
404-658	8-32 x 1/8	100	404-671	1/4-20 x 1/2	100	FILET FIN / FINE THREAD U.N.F. (S.A.E.)		
404-659	8-32 x 3/16	100	404-672	1/4-20 x 5/8	100	404-685	10-32 x 3/16	100
404-660	8-32 x 1/4	100	404-673	1/4-20 x 3/4	100	404-686	10-32 x 1/4	100
404-661	8-32 x 5/16	100	404-674	1/4-20 x 1	100	404-687	10-32 x 5/16	100
404-662	8-32 x 3/8	100	404-675	5/16-18 x 5/16	50	404-688	10-32 x 3/8	100
			404-676	5/16-18 x 3/8	50	404-689	10-32 x 1/2	100



VIS DE PRESSION À TÊTE CARRÉE / POINTE CUVETTE
SQUARE HEAD SET SCREWS / CUP POINT

FILET GROS / COARSE THREAD **U.N.C. (U.S.S.)**
 ACIER INOXYDABLE / STAINLESS STEEL **18-8 (304)**



18-8



NUMÉRO	DIMENSIONBTE				NUMÉRO	DIMENSIONBTE				NUMÉRO	DIMENSIONBTE			
404-700	1/4-20	x	3/8	100	404-716	3/8-16	x	1/2	25	404-726	1/2-13	x	3/4	25
401-324	1/4-20	x	1/2	100	404-717	3/8-16	x	5/8	25	401-332	1/2-13	x	1	25
404-702	1/4-20	x	5/8	100	401-329	3/8-16	x	3/4	25	404-728	1/2-13	x	1-1/4	25
401-325	1/4-20	x	3/4	100	401-330	3/8-16	x	1	25	401-333	1/2-13	x	1-1/2	25
404-704	1/4-20	x	7/8	100	404-720	3/8-16	x	1-1/4	25	404-730	1/2-13	x	1-3/4	25
404-705	1/4-20	x	1	100	401-331	3/8-16	x	1-1/2	25	401-334	1/2-13	x	2	25
404-706	1/4-20	x	1-1/4	100	404-722	3/8-16	x	1-3/4	25	404-732	1/2-13	x	2-1/2	25
404-707	1/4-20	x	1-3/8	100	404-723	3/8-16	x	2	25	404-733	1/2-13	x	3	25
404-708	1/4-20	x	1-1/2	100	404-724	3/8-16	x	2-1/2	25	404-734	1/2-13	x	4	25
					404-725	3/8-16	x	3	25					
401-326	5/16-18	x	1/2	50						404-735	5/8-11	x	1-1/4	25
404-710	5/16-18	x	5/8	50						404-736	5/8-11	x	1-1/2	25
401-327	5/16-18	x	3/4	50						404-737	5/8-11	x	2	25
401-328	5/16-18	x	1	50						404-738	5/8-11	x	2-1/2	25
404-713	5/16-18	x	1-1/8	50						404-739	5/8-11	x	3	10
404-714	5/16-18	x	1-1/4	50										
404-715	5/16-18	x	1-1/2	50										

TIGES FILLETÉES
THREADED RODS

UNC (U.S.S.)

18-8



ACIER INOXYDABLE / STAINLESS STEEL 18-8 (304)



UNC (Filet Gros) 36"/3'				UNC (Filet Gros) 72"/6'				UNC (Filet Gros) 144"/12'			
NUMÉRO		DIMENSION		NUMÉRO		DIMENSION		NUMÉRO		DIMENSION	
400-701A	2-56	x	36"	400-701-6	4-40	x	72"	400-701-12	4-40	x	144"
400-701	4-40	x	36"	400-702-6	6-32	x	72"	400-702-12	6-32	x	144"
400-702	6-32	x	36"	400-703-6	8-32	x	72"	400-703-12	8-32	x	144"
400-703	8-32	x	36"	400-704-6	10-24	x	72"	400-704-12	10-24	x	144"
400-704	10-24	x	36"	400-706-6	1/4-20	x	72"	400-706-12	1/4-20	x	144"
400-706	1/4-20	x	36"	400-708-6	5/16-18	x	72"	400-708-12	5/16-18	x	144"
400-708	5/16-18	x	36"	400-710-6	3/8-16	x	72"	400-710-12	3/8-16	x	144"
400-710	3/8-16	x	36"	400-712-6	7/16-14	x	72"	400-712-12	7/16-14	x	144"
400-712	7/16-14	x	36"	400-713-6	1/2-13	x	72"	400-713-12	1/2-13	x	144"
400-713	1/2-13	x	36"	400-726-6	9/16-12	x	72"	400-726-12	9/16-12	x	144"
400-726	9/16-12	x	36"	400-715-6	5/8-11	x	72"	400-715-12	5/8-11	x	144"
400-715	5/8-11	x	36"	400-716-6	3/4-10	x	72"	400-716-12	3/4-10	x	144"
400-716	3/4-10	x	36"	400-717-6	7/8-9	x	72"	400-717-12	7/8-9	x	144"
400-717	7/8-9	x	36"	400-718-6	1-8	x	72"	400-718-12	1-8	x	144"
400-718	1-8	x	36"	400-719-6	1-1/8-7	x	72"	400-719-12	1-1/8-7	x	144"
400-719	1-1/8-7	x	36"	400-720-6	1-1/4-7	x	72"	400-720-12	1-1/4-7	x	144"
400-720	1-1/4-7	x	36"								
400-720A	1-1/2-6	x	36"								

TIGES FILLETÉES
THREADED RODS

UNF (S.A.E.)

18-8



ACIER INOXYDABLE / STAINLESS STEEL 18-8 (304)



UNF (Filet Fin) 36"/3'				UNF (Filet Fin) 72"/6'				UNF (Filet Fin) 144"/12'			
NUMÉRO		DIMENSION		NUMÉRO		DIMENSION		NUMÉRO		DIMENSION	
400-705	10-32	x	36"	400-705-6	10-32	x	72"	400-705-12	10-32	x	144"
400-707	1/4-28	x	36"	400-707-6	1/4-28	x	72"	400-707-12	1/4-28	x	144"
400-709	5/16-24	x	36"	400-709-6	5/16-24	x	72"	400-709-12	5/16-24	x	144"
400-711	3/8-24	x	36"	400-711-6	3/8-24	x	72"	400-711-12	3/8-24	x	144"
402-684	7/16-20	x	36"	402-684-6	7/16-20	x	72"	402-684-12	7/16-20	x	144"
400-714	1/2-20	x	36"	400-714-6	1/2-20	x	72"	400-714-12	1/2-20	x	144"
402-686	9/16-18	x	36"	402-686-6	9/16-18	x	72"	402-686-12	9/16-18	x	144"
402-687	5/8-18	x	36"	402-687-6	5/8-18	x	72"	402-687-12	5/8-18	x	144"
402-688	3/4-16	x	36"	402-688-6	3/4-16	x	72"	402-688-12	3/4-16	x	144"
402-689	7/8-14	x	36"	402-689-6	7/8-14	x	72"	402-689-12	7/8-14	x	144"
402-690	1-14	x	36"	402-690-6	1-14	x	72"	402-690-12	1-14	x	144"
402-691	1-1/8-12	x	36"	402-691-6	1-1/8-12	x	72"	402-691-12	1-1/8-12	x	144"
402-692	1-1/4-12	x	36"	402-692-6	1-1/4-12	x	72"	402-692-12	1-1/4-12	x	144"

GOUPILLES CYLINDRIQUES
DOWEL PINS

18-8



ACIER INOXYDABLE / STAINLESS STEEL 18-8 (304)

NUMÉRO	DIMENSIONBTE				NUMÉRO	DIMENSIONBTE				NUMÉRO	DIMENSIONBTE			
405-001	1/32	x	3/16	100	405-039	3/16	x	1/2	100	405-079	1/2	x	3/4	25
405-002	1/32	x	1/4	100	405-040	3/16	x	5/8	100	405-080	1/2	x	1	25
405-003	1/32	x	5/16	100	405-041	3/16	x	3/4	100	405-081	1/2	x	1-1/4	25
405-004	1/32	x	3/8	100	405-042	3/16	x	7/8	100	405-082	1/2	x	1-1/2	25
405-005	1/32	x	7/16	100	405-043	3/16	x	1	100	405-083	1/2	x	1-3/4	25
405-006	1/32	x	1/2	100	405-044	3/16	x	1-1/4	100	405-084	1/2	x	2	25
405-007	1/32	x	5/8	100	405-045	3/16	x	1-1/2	100	405-085	1/2	x	2-1/4	25
405-008	1/32	x	3/4	100	405-046	3/16	x	1-3/4	50	405-086	1/2	x	2-1/2	25
					405-047	3/16	x	2	50	405-087	1/2	x	3	25
405-009	1/16	x	3/16	100						405-088	1/2	x	3-1/2	25
405-010	1/16	x	1/4	100	405-048	1/4	x	1/2	100	405-089	1/2	x	4	25
405-011	1/16	x	5/16	100	405-049	1/4	x	5/8	100					
405-012	1/16	x	3/8	100	405-050	1/4	x	3/4	100	405-202	5/38	x	5/8	25
405-013	1/16	x	7/16	100	405-051	1/4	x	7/8	100					
405-014	1/16	x	1/2	100	405-052	1/4	x	1	100					
405-015	1/16	x	5/8	100	405-053	1/4	x	1-1/4	100					
405-016	1/16	x	3/4	100	405-054	1/4	x	1-1/2	100					
405-017	1/16	x	7/8	100	405-055	1/4	x	1-3/4	50					
405-018	1/16	x	1	100	405-056	1/4	x	2	50					
405-019	3/32	x	3/16	100	405-057	5/16	x	1/2	100					
405-020	3/32	x	1/4	100	405-058	5/16	x	5/8	100					
405-021	3/32	x	5/16	100	405-059	5/16	x	3/4	100					
405-022	3/32	x	3/8	100	405-060	5/16	x	7/8	100					
405-023	3/32	x	7/16	100	405-061	5/16	x	1	100					
405-024	3/32	x	1/2	100	405-062	5/16	x	1-1/4	100					
405-025	3/32	x	5/8	100	405-063	5/16	x	1-1/2	100					
405-026	3/32	x	3/4	100	405-064	5/16	x	1-3/4	50					
405-027	3/32	x	7/8	100	405-065	5/16	x	2	50					
405-028	3/32	x	1	100										
					405-066	3/8	x	1/2	100					
405-029	1/8	x	3/8	100	405-067	3/8	x	5/8	100					
405-030	1/8	x	1/2	100	405-068	3/8	x	3/4	100					
405-031	1/8	x	5/8	100	405-069	3/8	x	7/8	100					
405-032	1/8	x	3/4	100	405-070	3/8	x	1	100					
405-033	1/8	x	7/8	100	405-071	3/8	x	1-1/4	100					
405-034	1/8	x	1	100	405-072	3/8	x	1-1/2	100					
405-035	1/8	x	1-1/4	100	405-073	3/8	x	1-3/4	100					
405-036	1/8	x	1-1/2	100	405-074	3/8	x	2	100					
405-037	1/8	x	1-3/4	100	405-075	3/8	x	2-1/4	50					
405-038	1/8	x	2	100	405-076	3/8	x	2-1/2	50					
					405-077	3/8	x	2-3/4	50					
					405-078	3/8	x	3	50					

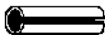
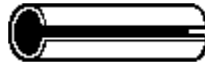
**GOUPILLES RESSORT 420**
SLOTTED SPRING PINS 420**420**

ACIER INOXYDABLE / STAINLESS STEEL 420

STANDARD					MÉTRIQUE									
NUMÉRO	DIMENSIONBTE													
					401-279	1/16	x	3/8	100	401-516	3	x	16mm	100
					401-278	1/16	x	1/2	100	401-514	3	x	20mm	100
					401-278A	1/16	x	5/8	100	401-517	3	x	24mm	100
					401-285	5/64	x	1/2	100	401-518	4	x	16mm	100
					402-486	5/64	x	1	100	401-519	4	x	20mm	100
					402-521	3/32	x	1/2	100	401-766	1/4	x	3/4	50
					402-522	3/32	x	3/4	100	401-300	1/4	x	1	50
					402-524A	3/32	x	1-1/4	100	401-301	1/4	x	1-1/4	50
					402-524	3/32	x	1	100	401-302	1/4	x	1-1/2	50
					402-540	3/32	x	1-1/2	100	402-612	1/4	x	1-3/4	50
					402-507	3/32	x	2	100	401-303	1/4	x	2	50
					401-281	1/8	x	1/4	100	401-303A	1/4	x	2-1/4	50
					401-286	1/8	x	3/8	100	401-303B	1/4	x	2-1/2	50
					401-287	1/8	x	1/2	100	402-517	1/4	x	3	50
					401-288	1/8	x	5/8	100	401-303E	1/4	x	3-1/4	50
					401-290	1/8	x	3/4	100	402-614	5/16	x	3/4	25
					401-291	1/8	x	7/8	100	401-305	5/16	x	1	25
					401-292	1/8	x	1	100	402-601	5/16	x	1-1/4	25
					402-622	1/8	x	1-1/4	100	402-478	5/16	x	1-1/2	25
					401-292A	1/8	x	1-3/8	100	402-602	5/16	x	1-3/4	25
					401-293	1/8	x	1-1/2	100	402-603	5/16	x	2	25
					401-293A	1/8	x	1-3/4	100	402-480	5/16	x	2-1/2	25
					401-293B	1/8	x	2	100	402-506	5/16	x	3	25
					402-624	5/32	x	3/4	100	402-508	3/8	x	1-1/4	25
					402-626	5/32	x	1	100	402-604	3/8	x	1-1/2	25
					402-628	5/32	x	1-1/4	100	402-606	3/8	x	1-3/4	25
					402-630	5/32	x	1-1/2	100	402-488	3/8	x	2	25
					402-490	3/16	x	1/2	100	402-510	3/8	x	2-1/2	25
					401-294	3/16	x	3/4	100	402-512	3/8	x	2-1/4	25
					401-295	3/16	x	7/8	100	402-514	3/8	x	2-3/4	25
					401-296	3/16	x	1	100	402-482	3/8	x	3	25
					401-297	3/16	x	1-1/4	100	402-484	3/8	x	4	25
					401-298	3/16	x	1-1/2	100	402-516	1/2	x	2	25
					401-299	3/16	x	2	100	402-518	1/2	x	3	25
					401-299B	3/16	x	2-1/2	100	402-520	1/2	x	3-1/4	25
NUMÉRO	DIMENSIONBTE				NUMÉRO	DIMENSIONBTE								

**GOUPILLES FENDUES**
SLOTTED SPRING PINS**18-8**

ACIER INOXYDABLE / STAINLESS STEEL 18-8 (304)

STANDARD

NUMÉRO	DIMENSION	BTE	NUMÉRO	DIMENSION	BTE	NUMÉRO	DIMENSION	BTE
403-357	1/16 x 3/8	100	400-684	5/32 x 3/4	100	403-372	5/16 x 3/4	25
400-667	1/16 x 1/2	100	400-685	5/32 x 1	100	403-373	5/16 x 1	25
400-668	1/16 x 5/8	100	400-686	5/32 x 1-1/4	100	403-374	5/16 x 1-1/4	25
400-669	1/16 x 3/4	100	400-687	5/32 x 1-1/2	100	403-375	5/16 x 1-1/2	25
400-670	1/16 x 1	100	400-688	5/32 x 2	100	403-376	5/16 x 1-3/4	25
400-671	1/16 x 1-1/4	100	402-466	5/32 x 2-1/2	100	403-377	5/16 x 2	25
400-672	1/16 x 1-1/2	100	402-468	5/32 x 3	100	403-378	5/16 x 2-1/2	25
402-454	1/16 x 2	100				403-379	5/16 x 3	25
			400-689	3/16 x 1	100	403-379A	5/16 x 4	25
400-673	3/32 x 1/2	100	400-690	3/16 x 1-1/4	100			
400-674	3/32 x 3/4	100	400-691	3/16 x 1-1/2	100	403-380	3/8 x 1-1/4	25
400-675	3/32 x 1	100	402-470	3/16 x 1-3/4	100	403-381	3/8 x 1-1/2	25
400-676	3/32 x 1-1/4	100	400-692	3/16 x 2	100	403-382	3/8 x 1-3/4	25
400-677	3/32 x 1-1/2	100	400-693	3/16 x 2-1/2	100	403-383	3/8 x 2	25
402-456	3/32 x 2	100	400-694	3/16 x 3	100	403-384	3/8 x 2-1/2	25
402-458	3/32 x 3	100				403-385	3/8 x 2-1/4	25
			403-363	7/32 x 1	100	403-386	3/8 x 2-3/4	25
403-358	1/8 x 1/2	100	403-364	7/32 x 1-1/4	100	403-387	3/8 x 3	25
403-359	1/8 x 5/8	100	403-365	7/32 x 1-1/2	100	403-388	3/8 x 4	25
400-678	1/8 x 3/4	100	403-366	7/32 x 1-3/4	100			
403-360	1/8 x 7/8	100	403-367	7/32 x 2	100	403-389	1/2 x 2	25
400-679	1/8 x 1	100				403-390	1/2 x 3	25
400-681	1/8 x 1-1/4	100	403-368	1/4 x 3/4	50	403-391	1/2 x 3-1/4	25
403-361	1/8 x 1-3/8	100	400-695	1/4 x 1	50			
400-682	1/8 x 1-1/2	100	400-696	1/4 x 1-1/4	50			
403-362	1/8 x 1-3/4	100	400-697	1/4 x 1-1/2	50			
400-683	1/8 x 2	100	403-369	1/4 x 1-3/4	50			
402-462	1/8 x 2-1/2	100	400-698	1/4 x 2	50			
402-464	1/8 x 3	100	403-370	1/4 x 2-1/4	50			
			400-699	1/4 x 2-1/2	50			
			400-700	1/4 x 3	50			
			403-371	1/4 x 3-1/4	50			



BOULONS DE PRÉCISION HEXAGONAUX HEXAGON CAP SCREWS

FILET GROS / COARSE THREAD **U.N.C (U.S.S.)**
ACIER INOXYDABLE / STAINLESS STEEL **316**

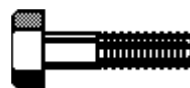

316



NUMÉRO	DIMENSION/BTE			NUMÉRO	DIMENSION			BTE	NUMÉRO	DIMENSION/BTE				
400-785	1/4-20	x	1/2	100	400-800A	5/16-18	x	3-1/2	10	401-004	7/16-14	x	1-3/4	25
404-740	1/4-20	x	5/8	100	404-752	5/16-18	x	4	10	401-005	7/16-14	x	2	20
400-786	1/4-20	x	3/4	100	405-260	5/16-18	x	4-1/2	10	401-006	7/16-14	x	2-1/2	20
404-741	1/4-20	x	7/8	100	405-261	5/16-18	x	5	10	401-007	7/16-14	x	3	10
400-787	1/4-20	x	1	100	405-262	5/16-18	x	5-1/2	10	401-008	7/16-14	x	3-1/2	10
400-788	1/4-20	x	1-1/4	100	405-263	5/16-18	x	6	10	401-009	7/16-14	x	4	10
400-789	1/4-20	x	1-1/2	100	404-753	3/8-16	x	1/2	50	401-010	7/16-14	x	4-1/2	10
400-789A	1/4-20	x	1-3/4	100	404-754	3/8-16	x	5/8	50	401-011	7/16-14	x	5	10
400-790	1/4-20	x	2	100	400-800	3/8-16	x	3/4	50	401-012	7/16-14	x	5-1/2	10
404-742	1/4-20	x	2-1/4	50	404-755	3/8-16	x	7/8	50	401-013	7/16-14	x	6	10
400-791	1/4-20	x	2-1/2	50	400-801	3/8-16	x	1	50	400-809A	1/2-13	x	3/4	25
404-743	1/4-20	x	2-3/4	50	400-802	3/8-16	x	1-1/4	25	400-810	1/2-13	x	1	25
400-792	1/4-20	x	3	25	400-803	3/8-16	x	1-1/2	25	400-811	1/2-13	x	1-1/4	25
404-744	1/4-20	x	3-1/2	25	400-804	3/8-16	x	1-3/4	25	400-812	1/2-13	x	1-1/2	25
404-745	1/4-20	x	4	25	400-805	3/8-16	x	2	25	400-813	1/2-13	x	1-3/4	25
405-256	1/4-20	x	4-1/2	25	404-756	3/8-16	x	2-1/4	25	400-814	1/2-13	x	2	20
405-257	1/4-20	x	5	25	400-806	3/8-16	x	2-1/2	25	400-815	1/2-13	x	2-1/4	20
405-258	1/4-20	x	5-1/2	25	404-757	3/8-16	x	2-3/4	25	400-816	1/2-13	x	2-1/2	20
405-259	1/4-20	x	6	25	400-807	3/8-16	x	3	10	404-758	1/2-13	x	2-3/4	20
404-746	5/16-18	x	1/2	100	400-808	3/8-16	x	3-1/2	10	400-817	1/2-13	x	3	10
404-747	5/16-18	x	5/8	100	400-809	3/8-16	x	4	10	400-817A	1/2-13	x	3-1/4	10
400-793	5/16-18	x	3/4	50	405-264	3/8-16	x	4-1/2	10	400-818	1/2-13	x	3-1/2	10
404-748	5/16-18	x	7/8	50	400-809AB	3/8-16	x	5	10	404-759	1/2-13	x	3-3/4	10
400-794	5/16-18	x	1	50	405-265	3/8-16	x	5-1/2	10	400-819	1/2-13	x	4	10
400-795	5/16-18	x	1-1/4	50	405-266	3/8-16	x	6	10	400-820	1/2-13	x	4-1/2	10
400-796	5/16-18	x	1-1/2	50	405-267	3/8-16	x	6-1/2	10	400-821	1/2-13	x	5	10
404-749	5/16-18	x	1-3/4	50	405-268	3/8-16	x	7	10	400-821A	1/2-13	x	5-1/2	10
400-797	5/16-18	x	2	50	405-269	7/16-14	x	3/4	25	400-822	1/2-13	x	6	5
404-750	5/16-18	x	2-1/4	25	401-001	7/16-14	x	1	25	404-760	1/2-13	x	6-1/2	5
400-798	5/16-18	x	2-1/2	25	401-002	7/16-14	x	1-1/4	25	404-761	1/2-13	x	7	5
404-751	5/16-18	x	2-3/4	25	401-003	7/16-14	x	1-1/2	25	404-762	1/2-13	x	7-1/2	5
400-799	5/16-18	x	3	25						404-763	1/2-13	x	8	5



ÉCROUS HEXAGONE U.N.C. / 316

NUMÉRO	DIMENSION	BTE
400-862	1/4-20	100
400-863	5/16-18	100
400-864	3/8-16	50
400-865	7/16-14	50
400-866	1/2-13	25



ÉCROUS BAGUE DE NYLON U.N.C. / 316

NUMÉRO	DIMENSION	BTE
402-530	1/4-20	100
402-531	5/16-18	100
402-532	3/8-16	50
403-392	7/16-14	50
402-533	1/2-13	25



RONDELLES PLATES 316

NUMÉRO	DIMENSION	BTE
400-873	1/4	100
400-874	5/16	100
400-875	3/8	100
400-875A	7/16	50
400-876	1/2	50



RONDELLES-RESSORTS 316

NUMÉRO	DIMENSION	BTE
400-928	1/4	100
400-929	5/16	100
400-930	3/8	100
400-930A	7/16	50
400-931	1/2	50

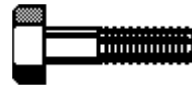
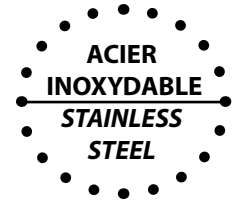
**BOULONS DE PRÉCISION HEXAGONAUX**
HEXAGON CAP SCREWS**316**FILET GROS / COARSE THREAD **U.N.C (U.S.S.)**
ACIER INOXYDABLE / STAINLESS STEEL **316**

NUMÉRO	DIMENSIONBTE			NUMÉRO	DIMENSIONBTE			NUMÉRO	DIMENSIONBTE					
400-823A	5/8-11	x	1	25	404-768	3/4-10	x	1	25	404-780	7/8-9	x	1-1/2	10
400-823	5/8-11	x	1-1/4	25	404-769	3/4-10	x	1-1/4	25	400-847	7/8-9	x	2	10
400-824	5/8-11	x	1-1/2	25	400-836	3/4-10	x	1-1/2	20	404-781	7/8-9	x	2-1/4	10
400-825	5/8-11	x	1-3/4	20	400-837	3/4-10	x	1-3/4	20	400-848	7/8-9	x	2-1/2	10
400-826	5/8-11	x	2	20	400-838	3/4-10	x	2	20	400-849	7/8-9	x	3	10
400-827	5/8-11	x	2-1/4	20	400-839	3/4-10	x	2-1/4	20	400-850	7/8-9	x	3-1/2	10
400-828	5/8-11	x	2-1/2	20	400-840	3/4-10	x	2-1/2	20	400-851	7/8-9	x	4	5
400-829	5/8-11	x	2-3/4	20	404-770	3/4-10	x	2-3/4	20	400-852	7/8-9	x	4-1/2	5
400-830	5/8-11	x	3	10	400-841	3/4-10	x	3	10	400-853	7/8-9	x	5	5
400-830A	5/8-11	x	3-1/4	10	404-771	3/4-10	x	3-1/4	10	404-782	7/8-9	x	5-1/2	5
400-831	5/8-11	x	3-1/2	10	400-842	3/4-10	x	3-1/2	10	400-854	7/8-9	x	6	5
400-831A	5/8-11	x	3-3/4	10	404-772	3/4-10	x	3-3/4	10	404-783	7/8-9	x	7	1
400-832	5/8-11	x	4	10	400-843	3/4-10	x	4	10	404-784	1-8	x	2	10
400-833	5/8-11	x	4-1/2	10	400-844	3/4-10	x	4-1/2	10	400-855	1-8	x	2-1/2	10
400-834	5/8-11	x	5	10	400-845	3/4-10	x	5	10	404-785	1-8	x	2-3/4	10
405-277	5/8-11	x	5-1/2	10	404-773	3/4-10	x	5-1/2	10	400-856	1-8	x	3	10
400-835	5/8-11	x	6	10	400-846	3/4-10	x	6	10	400-857	1-8	x	3-1/2	10
404-764	5/8-11	x	6-1/2	5	404-774	3/4-10	x	6-1/2	5	400-858	1-8	x	4	5
404-765	5/8-11	x	7	5	404-775	3/4-10	x	7	5	400-859	1-8	x	4-1/2	5
404-766	5/8-11	x	7-1/2	5	404-776	3/4-10	x	7-1/2	5	400-860	1-8	x	5	5
404-767	5/8-11	x	8	5	404-777	3/4-10	x	8	5	404-786	1-8	x	5-1/2	5
					404-778	3/4-10	x	9	1	400-861	1-8	x	6	5
					404-779	3/4-10	x	10	1	404-787	1-8	x	8	1

**ÉCROUS HEXAGONE**
U.N.C. / 316

NUMÉRO	DIMENSION	BTE
400-867	5/8-11	25
400-868	3/4-10	20
400-869	7/8-9	10
400-870	1-8	10

**ÉCROUS BAGUE DE NYLON**
U.N.C. / 316

NUMÉRO	DIMENSION	BTE
402-534	5/8-11	25
402-535	3/4-10	20
405-163	7/8-9	10
405-164	1-8	5

**RONDELLES PLATES**
316

NUMÉRO	DIMENSION	BTE
400-877	5/8	25
400-878	3/4	20
400-879	7/8	20
400-880	1	10

**RONDELLES-RESSORTS**
316

NUMÉRO	DIMENSION	BTE
400-932	5/8	25
400-933	3/4	20
400-934	7/8	20
400-935	1	10

**ÉCROUS HEXAGONES**
HEXAGONE NUTS

ACIER INOXYDABLE / STAINLESS STEEL

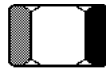
FILET GROS / COARSE THREAD
U.N.C. (U.S.S.)**316**FILET FIN / FINE THREAD
U.N.F. (S.A.E.)

NUMÉRO	DIMENSION	BTE	NUMÉRO	DIMENSION	BTE
400-862	1/4-20	100	405-166	1/4-28	100
400-863	5/16-18	100	405-167	5/16-24	100
400-864	3/8-16	50	405-168	3/8-24	50
400-865	7/16-14	50	405-169	7/16-20	50
400-866	1/2-13	25	405-170	1/2-20	25
400-866A	9/16-12	25	405-172	9/16-18	25
400-867	5/8-11	25	405-173	5/8-18	25
400-868	3/4-10	20	405-175	3/4-16	20
400-869	7/8-9	10	405-176	7/8-14	10
400-870	1-8	10	405-177	1-12	10
400-871	1-1/8-7	1	405-178	1-14	10
400-872	1-1/4-7	1	405-179	1-1/4-12	1
405-165	1-1/2-6	1	405-180	1-1/2-12	1

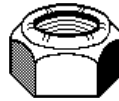
ÉCROUS AUTO-BLOQUANTS + NYLON
NYLON LOCKNUTSFILET GROS / COARSE THREAD **U.N.C (U.S.S.)**
ACIER INOXYDABLE / STAINLESS STEEL **316****316**

NUMÉRO	DIMENSION	BTE	NUMÉRO	DIMENSION	BTE
402-530	1/4-20	100	402-534	5/8-11	25
402-531	5/16-18	100	402-535	3/4-10	20
402-532	3/8-16	50	405-163	7/8-9	10
403-392	7/16-14	50	405-164	1-8	5
402-533	1/2-13	25			

ÉCROUS À OREILLES
WING NUTSFILET GROS / COARSE THREAD **U.N.C (U.S.S.)**
ACIER INOXYDABLE / STAINLESS STEEL **316****316**

NUMÉRO	DIMENSION	BTE	NUMÉRO	DIMENSION	BTE
405-270	1/4-20	100	405-274	1/2-13	25
405-271	5/16-18	100	405-275	5/8-11	25
405-272	3/8-16	50	405-276	3/4-10	20
405-273	7/16-14	50			

**RONDELLES PLATES**
FLAT WASHERACIER INOXYDABLE
STAINLESS STEEL**316****RONDELLES RESSORT**
SPRING - LOCKWASHERACIER INOXYDABLE
STAINLESS STEEL**316**

NUMÉRO	BOULON	I.D.	O.D.	ÉPAISSEUR	BTE
405-252	6				
405-254	8				
405-181	10	0.203	0.438	0.022 - 0.042	100
400-873	1/4	0.281	0.625	0.040 - 0.050	100
400-874	5/16	0.345	0.750	0.045 - 0.055	100
400-875	3/8	0.390	0.875	0.057 - 0.067	100
400-875A	7/16	0.469	1.125	0.057 - 0.067	50
400-876	1/2	0.563	1.250	0.068 - 0.088	50
400-877	5/8	0.688	1.500	0.068 - 0.088	25
400-878	3/4	0.813	1.750	0.095 - 0.115	20
400-879	7/8	0.938	2.000	0.095 - 0.115	20
400-880	1	1.062	2.000	0.095 - 0.115	10
400-881	1-1/8	1.187	2.500	0.115 - 0.135	10
400-882	1-1/4	1.312	2.750	0.115 - 0.135	10
	1-1/2	1.625	3.250	0.115 - 0.135	10

NUMÉRO	DIMENSION	BTE
405-571	8	100
400-927	10	100
400-928	1/4	100
400-929	5/16	100
400-930	3/8	100
400-930A	7/16	50
400-931	1/2	50
400-932	5/8	25
400-933	3/4	20
400-934	7/8	20
400-935	1	10
400-936	1-1/8	10
401-225	1-1/4	10
	1-1/2	10

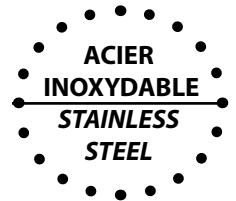
TIGES FILLETÉES - UNC
THREADED RODS - UNCACIER INOXYDABLE / STAINLESS STEEL **316****316**

UNC (Filet Gros) 36"/3'				UNC (Filet Gros) 72"/6'			
NUMÉRO	DIMENSION			NUMÉRO	DIMENSION		
405-182	1/4-20	x	36"	405-182-6	1/4-20	x	72"
405-183	5/16-18	x	36"	405-183-6	5/16-18	x	72"
405-184	3/8-16	x	36"	405-184-6	3/8-16	x	72"
405-185	1/2-13	x	36"	405-185-6	1/2-13	x	72"
405-186	5/8-11	x	36"	405-186-6	5/8-11	x	72"
405-187	3/4-10	x	36"	405-187-6	3/4-10	x	72"
405-188	7/8-9	x	36"	405-188-6	7/8-9	x	72"
405-190	1-8	x	36"	405-190-6	1-8	x	72"

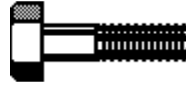
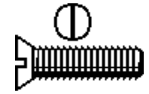
**BOULONS DE PRÉCISION HEXAGONAUX**
HEXAGON CAP SCREWSFILET GROS / COARSE THREAD **U.N.C (U.S.S.)****LAITON / BRASS****VIS À MACHINE TÊTE PLATE**
FENDUE / SLOTTED
MACHINE SCR. FLAT HEAD**LAITON**
BRASS

NUMÉRO	DIMENSION/BTE				NUMÉRO	DIMENSION/BTE				NUMÉRO	DIMENSION/BTE			
400-733	1/4-20	x	1/2	50	400-744	3/8-16	x	3/4	50	400-721	1/2-13	x	1	50
400-734	1/4-20	x	3/4	50	400-745	3/8-16	x	1	50	400-722	1/2-13	x	1-1/4	50
400-735	1/4-20	x	1	50	400-746	3/8-16	x	1-1/2	50	400-723	1/2-13	x	1-1/2	25
400-736	1/4-20	x	1-1/2	25	400-747	3/8-16	x	2	25	400-724	1/2-13	x	2	25
400-737	1/4-20	x	2	25	400-748	3/8-16	x	2-1/2	25	400-728	1/2-13	x	2-1/2	25
400-738	1/4-20	x	2-1/2	25	400-749	3/8-16	x	3	25	400-729	5/8-11	x	1-1/4	25
400-739	5/16-18	x	3/4	50	400-751	1/2-13	x	1	50	400-730	5/8-11	x	1-1/2	25
400-740	5/16-18	x	1	50	400-752	1/2-13	x	1-1/2	25	400-731	5/8-11	x	2	25
400-741	5/16-18	x	1-1/2	50	400-753	1/2-13	x	2	25					
400-742	5/16-18	x	2	25	400-754	1/2-13	x	2-1/2	25					
400-743	5/16-18	x	2-1/2	25	400-755	1/2-13	x	3	25					

RONDELLES PLATES
FLAT WASHERS**LAITON / BRASS****VENDU À LA LIVRE**
LBS / BTE**ÉCROUS HEXAGONES**
HEXAGONE NUTS**LAITON / BRASS**

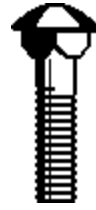

NUMÉRO	BOULON	I.D.	O.D.	ÉPAISSEUR	BTE	NUMÉRO	DIMENSION	BTE
400-761	4	0.118	0.281	0.025	2600	166-168	1/4-20	50
400-762	6	0.148	0.312	0.025	2200	166-176	1/4-28	50
400-763	6	0.145	0.375	0.032	1100	166-169	5/16-18	50
400-764	8	0.172	0.375	0.032	1200	166-177	5/16-24	50
400-765	8	0.172	0.437	0.036	730	166-170	3/8-16	50
400-766	10	0.200	0.437	0.036	790	166-178	3/8-24	50
400-767	10	0.200	0.500	0.040	500	166-172	7/16-14	25
400-768	12	0.227	0.500	0.040	530	166-179	7/16-20	25
400-769	12	0.227	0.562	0.040	400	166-174	1/2-13	25
400-770	1/4	0.260	0.562	0.040	430	166-180	1/2-20	25
400-771	1/4	0.260	0.687	0.051	200	166-175	5/8-11	25
400-772	5/16	0.336	0.750	0.064	145	166-220	3/4-10	10
400-773	5/16	0.336	0.875	0.064	100	166-221	7/8-9	10
400-774	3/8	0.395	0.875	0.064	108	166-222	1-8	10
400-775	3/8	0.395	1.000	0.081	62	166-222A	1-1/4-7	10
400-776	7/16	0.500	1.125	0.081	50			
400-777	1/2	0.562	1.250	0.091	37			
400-778	5/8	0.687	1.500	0.102	23			
400-779	3/4	0.812	1.875	0.114	13			
400-781	7/8	0.937	2.250	0.128	unitaire			
400-782	1	1.062	2.500	0.144	unitaire			
400-784	1-1/8	1.187	2.750	0.156	unitaire			

BOULONS DE CARROSSERIE
CARRIAGE BOLTS

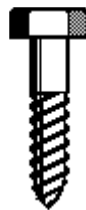
ACIER GALVANISÉ / HOT DIPPED GALVANIZED

NUMÉRO	DIMENSIONBTE	NUMÉRO	DIMENSIONBTE	NUMÉRO	DIMENSIONBTE
319-103	1/4-20 x 1 100	319-121	5/16-18 x 4 25	319-138	1/2-13 x 2 50
319-104	1/4-20 x 1-1/4 100	319-122	5/16-18 x 4-1/2 25	319-139	1/2-13 x 2-1/2 50
319-105	1/4-20 x 1-1/2 100	319-123	5/16-18 x 5 25	319-140	1/2-13 x 3 50
319-106	1/4-20 x 2 100	319-124	5/16-18 x 6 25	319-141	1/2-13 x 3-1/2 50
319-107	1/4-20 x 2-1/2 50	319-125	5/16-18 x 7 25	319-142	1/2-13 x 4 25
319-108	1/4-20 x 3 50	319-126	5/16-18 x 8 25	319-143	1/2-13 x 4-1/2 25
319-109	1/4-20 x 3-1/2 50			319-144	1/2-13 x 5 25
319-110	1/4-20 x 4 25	319-127A	3/8-16 x 1-1/4 100	319-145	1/2-13 x 6 25
319-111	1/4-20 x 4-1/2 25	319-127	3/8-16 x 1-1/2 100	319-146	1/2-13 x 7 25
319-112	1/4-20 x 5 25	319-128	3/8-16 x 2 100	319-147	1/2-13 x 8 25
319-113	1/4-20 x 6 25	319-129	3/8-16 x 2-1/2 100		
		319-130	3/8-16 x 3 50	319-148	5/8-11 x 3 25
319-114	5/16-18 x 1 100	319-131	3/8-16 x 3-1/2 50	319-149	5/8-11 x 4 25
319-115	5/16-18 x 1-1/4 100	319-132	3/8-16 x 4 50	319-150	5/8-11 x 5 25
319-116	5/16-18 x 1-1/2 100	319-133	3/8-16 x 4-1/2 50	319-151	5/8-11 x 6 25
319-117	5/16-18 x 2 100	319-134	3/8-16 x 5 50	319-152	5/8-11 x 7 25
319-118	5/16-18 x 2-1/2 50	319-135	3/8-16 x 6 50	319-153	5/8-11 x 8 25
319-119	5/16-18 x 3 50	319-136	3/8-16 x 7 25		
319-120	5/16-18 x 3-1/2 50	319-137	3/8-16 x 8 25		

TIRE-FONDS TÊTE HEXAGONE
LAG SCREW HEXAGON HEAD

ACIER GALVANISÉ / HOT DIPPED GALVANIZED

NUMÉRO	DIMENSIONBTE	NUMÉRO	DIMENSIONBTE	NUMÉRO	DIMENSIONBTE
319-171	1/4-20 x 1 100	319-184	5/16-18 x 4 50	319-196	1/2-13 x 2 50
319-172	1/4-20 x 1-1/4 100	319-185	5/16-18 x 5 25	319-197	1/2-13 x 2-1/2 25
319-173	1/4-20 x 1-1/2 100	319-186	5/16-18 x 6 25	319-198	1/2-13 x 3 25
319-174	1/4-20 x 2 100			319-199	1/2-13 x 3-1/2 25
319-175	1/4-20 x 2-1/2 50	319-187	3/8-16 x 1-1/2 100	319-200	1/2-13 x 4 25
319-176	1/4-20 x 3 50	319-188	3/8-16 x 2 100	319-201	1/2-13 x 5 25
319-177	1/4-20 x 3-1/2 50	319-189	3/8-16 x 2-1/2 50	319-202	1/2-13 x 6 10
319-178	1/4-20 x 4 50	319-190	3/8-16 x 3 50	319-203	1/2-13 x 7 10
		319-191	3/8-16 x 3-1/2 50	319-204	1/2-13 x 8 10
319-179	5/16-18 x 1-1/2 100	319-192	3/8-16 x 4 50		
319-180	5/16-18 x 2 100	319-193	3/8-16 x 4-1/2 25		
319-181	5/16-18 x 2-1/2 50	319-194	3/8-16 x 5 25		
319-182	5/16-18 x 3 50	319-195	3/8-16 x 6 25		
319-183	5/16-18 x 3-1/2 50				

RONDELLES PLATES FLAT WASHERS					ÉCROUS HEXAGONES HEXAGONE NUTS					
ACIER GALVANISÉ / HOT DIPPED GALVANIZED					 VENDU À LA LIVRE LBS / BTE			 ACIER GALVANISÉ HOT DIPPED GALVANIZED		
319-159	1/4	5/16	3/4	157	319-155	1/4-20	100			
319-160	5/16	3/8	7/8	91	319-156	5/16-18	100			
319-161	3/8	7/16	1	65	319-157	3/8-16	100			
319-162	7/16	1/2	1-1/4	34	319-157A	7/16-14	50			
319-163	1/2	9/16	1-3/8	24	319-158	1/2-13	50			
319-164	9/16	5/8	1-1/2	21	319-299	5/8-11	25			
319-165	5/8	11/16	1-3/4	12	319-300	3/4-10	20			
319-166	3/4	13/16	2	10	319-301	7/8-9	20			
319-167	7/8	15/16	2-1/4	7	319-303	1-8	20			
319-168	1	1-1/16	2-1/2	5	319-304	1-1/4	1			
319-169	1-1/8	1-1/4	2-3/4	5	319-305	1-1/8	1			
319-170	1-1/4	1-5/16	2-3/4	5	319-308	1-3/8	1			
319-170A	1-1/2		3-1/2	5	319-311	1-1/2	1			
					319-313	1-3/4	1			
					319-315	1-7/8	1			
					319-317	2	1			

CHARNIÈRES CONTINUES
CONTINUOUS HINGES

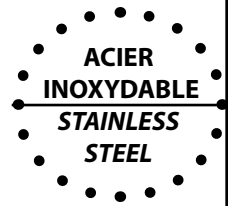
18-8



ACIER INOXYDABLE / STAINLESS STEEL **18-8**

NUMERO	OUVERT LARGEUR	LONGUEUR	EPAISSEUR	TIGE DIA.	ESPACE ARTICULATION
400-0008	3/4	72	.030	.060	1/4
400-0010	1	72	.030	.060	1/4
400-0011	1	72	.030	.090	1/4
400-0012	1	72	.037	.100	1/2
400-0004	1-1/16	72	.037	.100	1/2
400-0013	1-1/4	72	.037	.100	1/2
400-0005	1-1/2	72	.037	.100	1/2
400-0003	1-1/2	72	.060	.125	1/2
400-0014	1-1/2	72	.060	.125	1/2
400-0001	2	72	.060	.125	1/2
400-0015	2	72	.060	.187	1
400-0016	2	72	.075	.250	1
400-0017	2	84	.060	.125	1/2
400-0006	2-1/2	72	.060	.120	2
400-0018	3	72	.037	.100	1/2
400-0019	3	72	.060	.187	2
400-0002	3	72	.075	.250	1
400-0020	3	84	.125	.375	2
400-0007	4	72	.060	.125	2



LISTE DES COMPOSANTES POUR ACIER INOXYDABLE / TECHNICAL LISTE FOR STAINLESS STEEL

	Chromium	Nickel	Max. Carbon	Max. Mangan	Max. phosph	Max. Sulfur	Molybd	Max. Silicon	Copper	Other Elements	Tensile	Yield	Approx. Hardness	Special Characteristics
<p>300 SERIES AUSTENITIC STAINLESS - Accounts for 85% - 90% of stainless fasteners; best corrosion resistance of stainless alloys; non-magnetic before cold working; low heat conductivity; good strength at higher temperature; not hardenable by heat treatment.</p>														
18-8 Also referred to as 300 Series.	17-20% Usually 17-19%	8-13% Usually 8-10.5%	.08% Usually .03-.05%	2%	.2% Usually .045%	.03-15% Usually .03%		1%	0-4% Usually 2%-3%		80,000-150,000 usual range. After cold work : 100,000-125,000 typical for 1/4-5/8 dia; 100,000 typical for 3/4-1" dia; 80,000-90,000 typical over 1" dia.	40,000 min. After cold work : 80,000-90,000 typical 1/4-5/8 dia; 45,000-70,000 typical 3/4 & over dia.	B85-95	Most common designation for non-magnetic stainless fasteners; encompasses 30 to 40 various mixtures of 301, 302, 303, 304, 304, 305 and XM7
302	17-19%	8-10%	.15%	2%	.045%	.03%		1%			90,000-125,000 Typical : 100,000	40,000 min. Typical : 50,000-70,000	B85-95	Higher carbon content than 302HQ or 304; ductile; often used in wire-type products such as springs, screens, cable; common material for flat washers.
302HQ	17-19%	8-10%	.08% Usually .02 or less	2%	.045%	.03%		1%	3-4%		80,000-140,000 usual range. After cold work : 100,000-120,000 typical for 1/4-5/8 dia. 100,000 typical for 3/4-1" dia; 80,000 typical over 1" dia.	40,000 min. After cold work : 80,000-90,000 typical 1/4-5/8 dia; 45,000-65,000 typical 3/4 & over dia.	B85-95	Extra copper reduces work hardening during cold forming; commonly used for machine screws, metal screws, small nuts.
XM7	17-19%	8-10%	.10%	2%	.045%	.03%		1%	3-4%		See 302HQ			Similar to 302HQ
303	17-10%	8-10%	.15%	.2%	.02%	.15 Min.		1%			90,000-125,000	40,000 min.	B85-95	Good for machineability in products such as large nuts ; not for cold forming; higher carbon and sulfur may lower corrosion resistance.
304	18-20%	8-10.5%	.08%	2%	.45%	.03%		1%			85,000-150,000 usual range. After cold work : 125,000 typical for 1/4-5/8 dia; 100,000 typical for 3/4-1" dia; 90,000 typical above 1" dia.	40,000 min. After cold work : 90,000 typical for 1/4-5/8 dia ; 50,000-70,000 typical for 3/4 & over dia.	B85-95	Most popular stainless for hex head cap screws; also frequently used for flat washers.
304L	18-20%	8-12%	.03%	2%	.045%	.03%		1%			Slightly lower than 304 due to lower carbon content			Low carbon increases corrosion resistance and welding capacity.
305	17-19%	10.5-13%	.12%	2%	.045%	.03%		1%			See 302HQ			High nickel content lowers work hardening during severe cold forming and keeps parts non-magnetic.
316	16-18%	10-14%	.08%	2%	.045%	.03%	2-3%	1%			85,000-140,000 usual range. After cold work : 120,000 typical for 3/4-1" dia; 80,000 typical above 1" dia.	40,000 min. After cold work : 80,000-90,000 typical for 1/4-5/8 dia; 50,000-70,000 typical for 3/4 & over dia.	B85-95	Addition of molybdenum increases corrosion resistance to chloride and sulfides.
309	22-24%	12-15%	.2%	2%	.045%	.03%		1%			100,000-120,000	60,000-80,000	B85-95	Higher chromium and nickel give better orrosion resistance at high temperatures (1900 deg F)
310	24-28%	19-22%	.25%	2%	.045%	.035		1.5%			See 309			Similar to 309 at high temperatures; extra corrosion resistance to salt.
317	18-20%	11-15%	.08%	2%	.45%	.03%	3-4%	1%			See 309			High chromium and nickel with added molybdenum give greater tensile strength and corrosion resistance at high temperatures.
321	17-19%	9-12%	.08%	2%	.045%	.03%		1%		Titanium - 5 times carbon content	See 309			Titanium improves intergranular corrosion resistance, by avoiding carbide precipitation; good for intermittent heating applications and corrosion resistance to 1600 deg. F.
347	17-19%	9-13%	.08%	2%	.045%	.03%		1%		Columbian & Tantalum - 10 times carbon.	See 309			Columbian and Tantalum give similar properties to 321.

LISTE DES COMPOSANTES POUR ACIER INOXYDABLE / TECHNICAL LISTE FOR STAINLESS STEEL

	Chromium	Nickel	Max. Carbon	Max. Mangan	Max. phosph	Max. Sulfur	Molybd	Max. Silicon	Copper	Other Elements	Tensile	Yield	Approx. Hardness	Special Characteristics
400-SERIES MARTENSITIC STAINLESS: About 5% of stainless fasteners; magnetic; no nickel and high carbon content mean the lowest corrosion resistance among the different types of stainless.														
400 Mixture Martensitic	11.5 - 14%		.30% Usually .15-.30%	1.25% Usually 1%	.06% Usually .04%	.15% Usually .03%		1%			180,000-250,000 if heat treated	150,000-200,000 if heat treated	C34-45	Often a mixture of different 400 materials, usually with carbon content towards high end of max, giving greater strength but lowering corrosion resistance.
410	11.5-13.5%		.15%	1%	.04%	.03%		1%			180,000 heat treated	150,000 heat treated	C34	Higher carbon content gives strength; most popular of the grades with 12% chrome; used in highly stressed conditions.
416	12-14%		.15%	1.25%	.06%	.15%		1%			See 410			Higher sulfur content helps machineability but lowers corrosion resistance.
420	12-14%		.30% Norm. 15% Min.	1%	.04%	.03%		1%			250,000 heat treated	200,000 heat treated	C45	Higher carbon gives greater strength but lowers corrosion resistance.
FERRITIC STAINLESS: A few percent of stainless fasteners; magnetic; not hardenable by heat treatment; high chromium content helps corrosion resistance.														
405	11.5-14.5%		.08%	1%	.04%	.03%		1%		.1-3% Alum.	70,000-75,000	40,000-45,000	B65-B75	Low corrosion resistance; added aluminum lowers tensile strength
430	16-18%		.12%	1%	.04%	.03%		1%			See 405			Most popular of ferritic stainless; higher carbon content adds strength; used for cold forming and hot forging but low machineability.
PRECIPITATION HARDENED STAINLESS, MONEL, AND ALUMINIUM														
630	15.5-17.5%	3.5%	.07%	1%	.04%	.03%	1%		3-5%	Columbian & Tantalum-15.4 5%	135,000	105,000	C28	Infrequently used; high corrosion resistance; strength and ductility in high and low temperatures due to solution annealing and hardening.
Monel 400		63-70%	.3%	2%		.5%				2.5%-Iron, .5%-Alum, .15% Sulf, Remainder copper	80,000-125,000	40,000-70,000	B70	Most commonly used nickel-copper alloy for cold forming; excellent corrosion resistance in heat and salt water.
Aluminum 2024	.1%			.3-9%		.5%			3.8-4.9%	.25% Zinc, 1.2-1.8% Magnesium, Remainder Alum.	60,000 heat treated	50,000 heat treated	B60 heat treated	Most popular of aluminum alloys; needs heat treatment for strength.
BRASS AND BRONZE														
Brass Alloy 270									65%	35% Zinc	70,000	45,000	B65	Good cold forming due to high copper content; also used for milled from bar nuts.
Brass Alloy 360									61.5%	3% Lead remainder Zinc	50,000	30,000	B55	Good machineability due to added lead; good for screw machine parts.
Commercial Brass									60-65%	35-40% Zinc, .05-.15 Lead	55,000	35,000	B60	Easier to cold form as copper content increases; as copper content decreases, the metal becomes stronger and harder.
Bronze Alloy 651		.06%		.07%				2.0%	96.0% min.	.05% Lead max. 1.5% Zinc max.	70,000-80,000	35,000-45,000	B70-B75	Generally used for hex head cap screws.
Bronze Alloy 655				1.5%				3.8%	94.8% min.	.05% Lead max. 1.5% Zinc max.	See Bronze 651			Used for hot forged fasteners.
Commercial Bronze								2-4%	94-96%	.05-.8% Lead, .05-1.5% Zinc	See Bronze 651			Addition of lead helps machineability.
Phosphorus Bronze			.3%						95%	5% Tin	60,000	35,000	B60	Tin increases strength; phosphorus helps against stress corrosion; excellent cold forming properties.
Naval Bronze									59-62%	.5-1% Tin, 2% Lead remainder Zinc	70,000	30,000	B65	Addition of tin gives better corrosion resistance against salt water.

SP885 NETTOYANT POUR ACIER INOXYDABLE

Un mélange à base d'eau qui élimine facilement la majorité des tâches d'eau et d'huile sur l'acier inoxydable et les autres surfaces métalliques.

• Le revêtement invisible résiste aux empreintes digitales, aux marques d'eau et à la rouille.

• Agréé par l'USDA

Utilisez le SP885 sur l'équipement de cuisine, les fontaines d'eau, les portes d'ascenseurs, le mobilier.

SP885 Cannette de 20oz (poids net 17 oz)

caisse de 12



ASHP-29 ENSEMBLE DE FORET SERIE HAUTE PERFORMANCE OR ET NOIR

Ensemble de foret à haut rendement, de qualité industrielle.

Avantages:

- Pointe de 135 degrés.
- Une durée de vie plus longue.
- Perce des matières plus dure.
- Coupe plus facilement, donc moins de résistance.
- Excellent pour les aciers durs tel que l'ACIER INOXYDABLE

Comprend 29 pièces
de 1/16 à 1/2 en 64^{ième}

Numéro	Dimension	Boîte	Numéro	Dimension	Boîte	Numéro	Dimension	Boîte
SHP1160	1/16	12	SHP1364	13/64	12	SHP2364	23/64	6
SHP5640	5/64	12	SHP7320	7/32	12	SHP3800	3/8	6
SHP3320	3/32	12	SHP1564	15/64	12	SHP2564	25/64	6
SHP7640	7/64	12	SHP1400	1/4	12	SHP1332	13/32	6
SHP1800	1/8	12	SHP1764	17/64	12	SHP2764	27/64	6
SHP9640	9/64	12	SHP9320	9/32	12	SHP7160	7/16	6
SHP5320	5/32	12	SHP1964	19/64	6	SHP2964	29/64	6
SHP1164	11/64	12	SHP5160	5/16	6	SHP1532	15/32	6
SHP3160	3/16	12	SHP2164	21/64	6	SHP3164	31/64	6
			SHP1132	11/32	6	SHP1200	1/2	6

SP208 HUILE DE COUPE

Un lubrifiant excellent, spécialement formulé pour tous les opérateurs d'usinage des ferreux. Il prolonge la durée des outils, réduisant le besoin de les aiguiser élimine les temps morts. Recommandé pour tous les métaux, y compris L'ACIER INOXYDABLE et les métaux mous tels que l'aluminium, le laiton et le cuivre.

- Colle à la surface.
- Vaporisation par jet pour accroître la précision.
- Agréé par l'USDA.
- Comprend un actuateur en sus avec tube de rallonge.

Utilisez SP208 pour percer, couper, fileter, scier, meuler ou brocher.

SP208 Cannette de 16 oz (poids net 12oz)

caisse de 12

AUSSI DISPONIBLE EN VRAC

SP208-4L Contenant de 4 litres

SP208-20L Contenant de 20 Litres



**CONTACTEZ-NOUS
GET IN TOUCH**

1 800 463-5259

info@prdistribution.ca

Notre service, toujours en tête.^{MD} Our service, one step ahead.TM

prdistribution.ca

1 800 463-5259
info@prdistribution.ca

Siège social • Head Office
6500, rue Zéphirin-Paquet
Québec QC G2C 0M3
T 418 872-6018 F 418 872-6583

Succursale • Branch
1100, rue de la Manic
Saguenay QC G7K 1A2
T 418 545-1100 F 418 545-1104

