















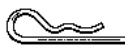
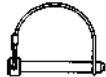







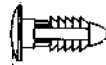



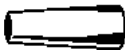

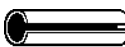
PRD 



Goupilles
Pins

TABLE DES MATIÈRES / CONTENTS

	Cales / Shims	p.2-4		Goupilles à anneaux - traction Pull pins	p.27
	Bagues de retenue / Retaining rings	p.5-9		Billes piston Ball plungers	p.27
	Goupilles fendues / Hammer lok cotter pins	p.10-11		Clavettes d'essieu Lynch pins	p.28
	Agrafes pour goupilles d'attelage Hitch pin clips	p.12-14		Goupilles de verrouillage Wire lock pins	p.28
	Agrafes "Grip®" Grip® clips	p.15		Nauts de hauban Nylon lanyards	p.29
	Agrafes de sécurité Safety pin fasteners	p.15		Épingles attache Hair pin clips	p.30
	Agrafes à double boucle double loop hairpin cotter	p.15		Bagues de retenue à serrer Crimp ring retainers	p.31
	Agrafes à anneaux "Rue©" Rue© ring locking cotters	p.16		Rivets pression Press lock rivets	p.31
	Agrafes à barrure "Bow-Tie©" Bow-Tie© locking cotters	p.17-18		Goupilles cylindriques Dowel pins	p.32-33
	Crochets en "S" "S" Hooks	p.19-20		Goupilles coniques Taper pins	p.33-34
	Goupilles à axe de chape ajustable Adjustable Clevis pin	p.21		Goupilles à ressort Spring tensions pins	p.35-36
	Goupilles à axe de chape Clevis pin	p.22-24		Goupilles à ressort - spirale Coiled spring pins	p.37-38
	Goupilles de verrouillage Bent arm pins	p.24		Clavettes "Woodruff" Woodruff keys	p.39
	Goupilles d'attelage avec anneaux Detent ring pin	p.25		Barres à clavettes Machine key stock	p.40-41, p.43-47
	Goupilles de verrouillage positive positive lock pins	p.26		Acier en rondin de précision Drill rod rounds	p.42

CALES SHIMS

PLAQUÉ ZINC / ZINC PLATED

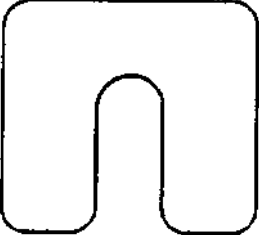
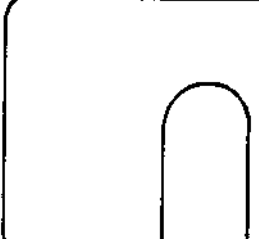
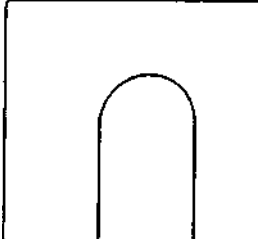
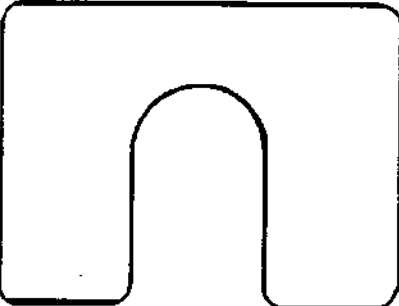
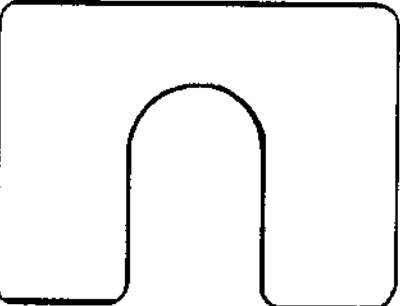
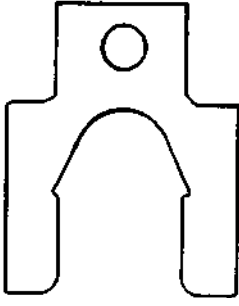
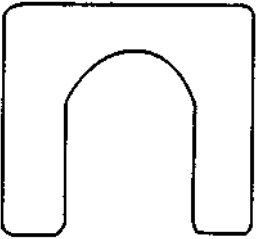
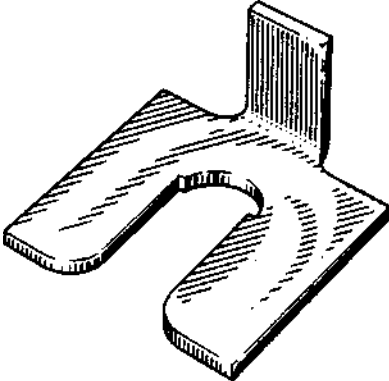

 <p>1-1/4" x 1-1/8" W/ 3/8" SLOT</p> <p>182-101 1/16" ÉPAIS BTE/100 182-104 1/8" ÉPAIS BTE/100</p>	 <p>1-3/4" x 1-1/4" W/ 1/2" SLOT</p> <p>182-102 1/16" ÉPAIS BTE/50 182-105 1/8" ÉPAIS BTE/50</p>	 <p>1-3/4" x 1-1/4" W/ 1/2" SLOT</p> <p>182-113 1/8" ÉPAIS BTE/50</p>
 <p>2" x 1-1/2" W/ 3/4" SLOT</p> <p>182-103 1/8" ÉPAIS BTE/50</p>	 <p>2" x 1-1/2" W/ 5/8" SLOT</p> <p>182-112 1/8" ÉPAIS BTE/50</p>	 <p>1-3/16" x 1-15/32" W/ 5/8" SLOT</p> <p>182-107 1/64" ÉPAIS BTE/25 182-108 1/32" ÉPAIS BTE/25 182-109 1/16" ÉPAIS BTE/25 182-110 1/8" ÉPAIS BTE/25</p>
 <p>1-3/8" x 1-1/4" W/ 5/8" SLOT</p> <p>182-151 1/8" ÉPAIS BTE/50 182-152 3/16" ÉPAIS BTE/25</p>	 <p>1-11/32" WIDE x 1-7/16" LONG 7/16" SLOT, 5/8" LONG 90° ANGLE TAB</p> <p>182-146 1/16" ÉPAIS BTE/25</p>	

CALES "OA" "OA" SHIMS



ACIER INOXYDALE 304 / 304 STAINLESS STEEL

2" x 2" W/ 5/8" SLOT

182-160	.001"	ÉPAIS	BTE/20
182-161	.002"	ÉPAIS	BTE/20
182-162	.003"	ÉPAIS	BTE/20
182-163	.004"	ÉPAIS	BTE/20
182-164	.005"	ÉPAIS	BTE/20
182-165	.010"	ÉPAIS	BTE/20
182-166	.015"	ÉPAIS	BTE/20
182-167	.020"	ÉPAIS	BTE/20
182-168	.025"	ÉPAIS	BTE/20
182-169	.050"	ÉPAIS	BTE/20
182-170	.075"	ÉPAIS	BTE/20
182-171	.100"	ÉPAIS	BTE/20
182-172	.125"	ÉPAIS	BTE/20

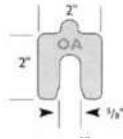

ASSORTIMENT DE CALE «OA» COFFRET DE METAL - JAUNE SÉCURITÉ

ASF-2161	10 DE CHAQUE
ASF-2162	20 DE CHAQUE



CALES "OB" "OB" SHIMS



ACIER INOXYDALE 304 / 304 STAINLESS STEEL

3" x 3" W/ 3/4" SLOT

182-173	.001"	ÉPAIS	BTE/20
182-174	.002"	ÉPAIS	BTE/20
182-175	.003"	ÉPAIS	BTE/20
182-176	.004"	ÉPAIS	BTE/20
182-177	.005"	ÉPAIS	BTE/20
182-178	.010"	ÉPAIS	BTE/20
182-179	.015"	ÉPAIS	BTE/20
182-180	.020"	ÉPAIS	BTE/20
182-181	.025"	ÉPAIS	BTE/20
182-182	.050"	ÉPAIS	BTE/20
182-183	.075"	ÉPAIS	BTE/20
182-184	.100"	ÉPAIS	BTE/20
182-185	.125"	ÉPAIS	BTE/20

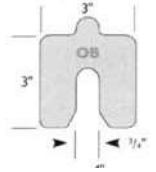

ASSORTIMENT DE CALE «OB» COFFRET DE METAL - JAUNE SÉCURITÉ

A SF-2163	10 DE CHAQUE
ASF-2164	20 DE CHAQUE



CALES "OC" "OC" SHIMS



ACIER INOXYDALE 304 / 304 STAINLESS STEEL

4" x 4" W/ 1-1/4" SLOT

182-186	.001"	ÉPAIS	BTE/20
182-187	.002"	ÉPAIS	BTE/20
182-188	.003"	ÉPAIS	BTE/20
182-189	.004"	ÉPAIS	BTE/20
182-190	.005"	ÉPAIS	BTE/20
182-191	.010"	ÉPAIS	BTE/20
182-192	.015"	ÉPAIS	BTE/20
182-193	.020"	ÉPAIS	BTE/20
182-194	.025"	ÉPAIS	BTE/20
182-195	.050"	ÉPAIS	BTE/20
182-196	.075"	ÉPAIS	BTE/20
182-197	.100"	ÉPAIS	BTE/20
182-198	.125"	ÉPAIS	BTE/20

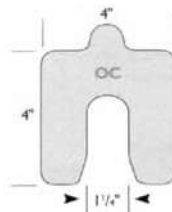

ASSORTIMENT DE CALE «OC» COFFRET DE METAL - JAUNE SÉCURITÉ

ASF-2165	10 DE CHAQUE
ASF-2166	20 DE CHAQUE



CALES "OD" "OD" SHIMS



ACIER INOXYDALE 304 / 304 STAINLESS STEEL

5" x 5" W/ 1-5/8" SLOT

182-199	.001"	ÉPAIS	BTE/20
182-200	.002"	ÉPAIS	BTE/20
182-201	.003"	ÉPAIS	BTE/20
182-202	.004"	ÉPAIS	BTE/20
182-203	.005"	ÉPAIS	BTE/20
182-204	.010"	ÉPAIS	BTE/20
182-205	.015"	ÉPAIS	BTE/20
182-206	.020"	ÉPAIS	BTE/20
182-207	.025"	ÉPAIS	BTE/20
182-208	.050"	ÉPAIS	BTE/20
182-209	.075"	ÉPAIS	BTE/20
182-210	.100"	ÉPAIS	BTE/20
182-211	.125"	ÉPAIS	BTE/20

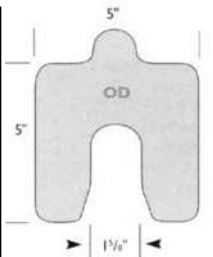

ASSORTIMENT DE CALE «OD» COFFRET DE METAL - JAUNE SÉCURITÉ

ASF-2167	10 DE CHAQUE
ASF-2168	20 DE CHAQUE



CALES
CASTER AND CAMBER SHIMS

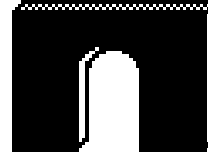

PLAQUÉ ZINC / ZINC PLATED

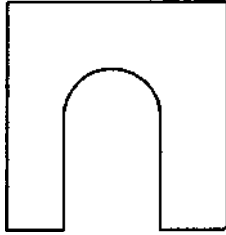

1-1/8" x 1-1/8" W/ 1/2" SLOT

182-114	1/64"	ÉPAIS	BTE/50
182-115	1/32"	ÉPAIS	BTE/50
182-116	1/16"	ÉPAIS	BTE/50
182-117	1/8"	ÉPAIS	BTE/50

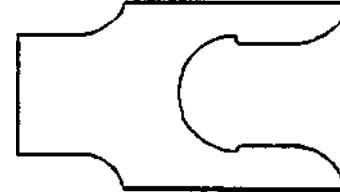

1" x 1-11/16" x 37/64" BOLT OPENING

182-126	1/32"	ÉPAIS	BTE/50
182-127	1/16"	ÉPAIS	BTE/50
182-128	1/8"	ÉPAIS	BTE/50

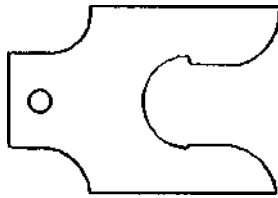

15/16" x 1-3/8" x 7/16" BOLT OPENING

182-123	1/32"	ÉPAIS	BTE/50
182-124	1/16"	ÉPAIS	BTE/50
182-125	1/8"	ÉPAIS	BTE/50

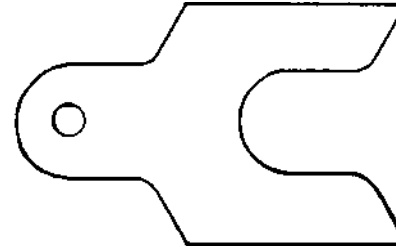

1-1/4" x 2" x 17/32" SLOT

182-132	3/16"	ÉPAIS	BTE/50
---------	-------	-------	--------

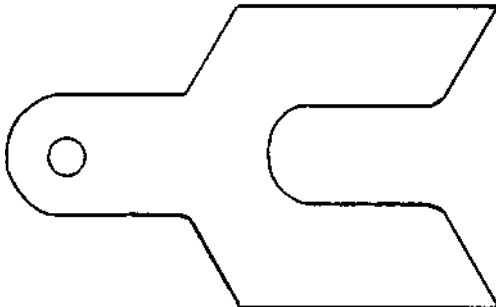

1-1/2" x 2-1/2" x 9/16" SLOT

182-129	1/32"	ÉPAIS	BTE/50
182-130	1/16"	ÉPAIS	BTE/50
182-131	1/8"	ÉPAIS	BTE/50



NUMÉRO	DIA. TIGE	DIA. FENTE	LARGEUR FENTE	ÉPAIS	BTE
184-080	1/8	*	*	*	*
184-084	3/16	*	*	*	*
184-101	1/4	.268	.020	.015	50
184-102	5/16	.330	.020	.015	50
184-103	3/8	.397	.029	.025	50
184-104	7/16	.461	.029	.025	50
184-010	29/64	.477	.029	.025	50
184-105	1/2	.530	.039	.035	25
184-106	9/16	.596	.039	.035	25
184-107	5/8	.665	.039	.035	10
184-120	11/16	.732	.039	.035	10
184-108	3/4	.796	.039	.035	10
184-126	13/16	.862	.046	.042	10
184-109	7/8	.931	.046	.042	10
184-129	15/16	1.000	.046	.042	10
184-110	1	1.066	.046	.042	10
184-133	1-1/16	1.130	.056	.050	10
184-111	1-1/8	1.197	.056	.050	10
184-134	1-3/16	1.262	.056	.050	10
184-112	1-1/4	1.330	.056	.050	10
184-136	1-5/16	1.396	.056	.050	10
184-139	1-3/8	1.461	.056	.050	10
184-142	1-7/16	1.528	.056	.050	10
184-145	1-1/2	1.594	.056	.050	10
184-148	1-9/16	1.658	.068	.062	10
184-151	1-5/8	1.725	.068	.062	10
184-153	1-11/16	1.792	.068	.062	10
184-155	1-3/4	1.858	.068	.062	10
184-156	1-13/16	1.922	.068	.062	10
184-158	1-7/8	1.989	.068	.062	10
184-231	1-15/16	2.056	.068	.062	10

NUMÉRO	DIA. TIGE	DIA. FENTE	LARGEUR FENTE	ÉPAIS	BTE
184-163	2	2.122	.068	.062	10
184-232	2-1/16	2.186	.086	.078	10
184-167	2-1/8	2.251	.086	.078	10
184-166	2-3/16	2.318	.086	.078	10
184-169	2-1/4	2.382	.086	.078	10
184-170	2-5/16	2.450	.086	.078	10
184-171	2-3/8	2.517	.086	.078	10
184-233	2-7/16	2.584	.086	.078	10
184-175	2-1/2	2.648	.086	.078	10
184-234	2-17/32	2.681	.086	.078	5
184-235	2-9/16	2.714	.103	.093	5
184-236	2-5/8	2.781	.103	.093	5
184-237	2-11/16	2.848	.103	.093	5
184-185	2-3/4	2.914	.103	.093	5
184-186	2-13/16	2.980	.103	.093	5
184-187	2-7/8	3.051	.103	.093	5
184-188	3	3.182	.103	.093	5
184-189	3-1/16	3.248	.120	.109	5
184-190	3-1/8	3.315	.120	.109	5
184-191	3-5/32	3.348	.120	.109	5
184-192	3-1/4	3.446	.120	.109	5
184-193	3-11/32	3.546	.120	.109	5
184-194	3-15/32	3.675	.120	.109	5
184-195	3-1/2	3.710	.120	.109	5
184-196	3-9/16	3.776	.120	.109	1
184-197	3-5/8	3.841	.120	.109	1
184-198	3-3/4	3.974	.120	.109	1
184-199	3-7/8	4.107	.120	.109	1
184-200	3-15/16	4.174	.120	.109	1
184-201	4	4.240	.120	.109	1
184-205	4-1/4				1
184-207	4-3/4				1
184-208	5	5.260	.120	.109	1

BAGUES DE RETENUE
RETAINING RINGS

SÉRIE R3100 / 5100 / SH

EXTÉRIEUR / EXTERNAL

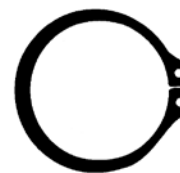

NUMÉRO	DIA. TIGE	DIA. FENTE	LARGEUR FENTE	ÉPAIS	BTE
186-101	1/8	.117	.012	.010	50
186-010	5/32	.146	.012	.010	50
186-136	3/16	.175	.018	.015	50
186-011	7/32	.205	.018	.015	50
186-012	15/64	.222	.018	.015	50
186-102	1/4	.230	.029	.025	50
186-103	9/32	.261	.029	.025	50
186-104	5/16	.290	.029	.025	50
186-105	11/32	.321	.029	.025	50
186-106	3/8	.352	.029	.025	50
186-107	13/32	.382	.029	.025	50
186-108	7/16	.412	.029	.025	50
186-230	15/32	.443	.029	.025	50
186-109	1/2	.468	.039	.035	25
186-110	9/16	.530	.039	.035	25
186-111	19/32	.559	.039	.035	25
186-112	5/8	.588	.039	.035	10
186-231	43/64	.631	.039	.035	10
186-113	11/16	.646	.046	.042	10
186-114	3/4	.704	.046	.042	10
186-232	25/32	.733	.046	.042	10
186-115	13/16	.762	.046	.042	10
186-116	7/8	.821	.046	.042	10
186-117	15/16	.882	.046	.042	10
186-233	63/64	.926	.046	.042	10
186-118	1	.940	.046	.042	10
186-119	1-1/16	.998	.056	.050	10
186-120	1-1/8	1.059	.056	.050	10
186-121	1-3/16	1.118	.056	.050	10
186-122	1-1/4	1.176	.056	.050	10
186-140	1-5/16	1.232	.056	.050	10
186-150	1-3/8	1.291	.056	.050	10

NUMÉRO	DIA. TIGE	DIA. FENTE	LARGEUR FENTE	ÉPAIS	BTE
186-154	1-7/16	1.350	.056	.050	10
186-123	1-1/2	1.406	.056	.050	10
186-158	1-9/16	1.468	.068	.062	10
186-160	1-5/8	1.529	.068	.062	10
186-141	1-11/16	1.589	.068	.062	10
186-124	1-3/4	1.650	.068	.062	10
186-234	1-13/16	1.708	.068	.062	10
186-166	1-7/8	1.769	.068	.062	10
186-235	1-31/32	1.857	.068	.062	10
186-125	2	1.886	.068	.062	10
186-236	2-1/16	1.946	.086	.078	10
186-167	2-1/8	2.003	.086	.078	10
186-237	2-5/32	2.032	.086	.078	10
186-126	2-1/4	2.120	.086	.078	10
186-222	2-5/16	2.178	.086	.078	10
186-223	2-3/8	2.239	.086	.078	10
186-224	2-7/16	2.299	.086	.078	10
186-127	2-1/2	2.360	.086	.078	10
186-169	2-5/8	2.481	.086	.078	10
186-170	2-11/16	2.541	.086	.078	10
186-171	2-3/4	2.602	.103	.093	10
186-172	2-7/8	2.721	.103	.093	10
186-173	2-15/16	2.779	.103	.093	10
186-174	3	2.838	.103	.093	5
186-175	3-1/16	2.898	.103	.093	5
186-176	3-1/8	2.957	.103	.093	5
186-177	3-5/32	2.986	.103	.093	5
186-178	3-1/4	3.076	.103	.093	5
186-179	3-11/32	3.166	.103	.093	5
186-180	3-7/16	3.257	.103	.093	5
186-181	3-1/2	3.316	.120	.109	5
186-189	4				5
186-193	4-3/8				5

Tous ces produits sont aussi disponible en acier inoxydable / All products also available in stainless steel

SERIE 184

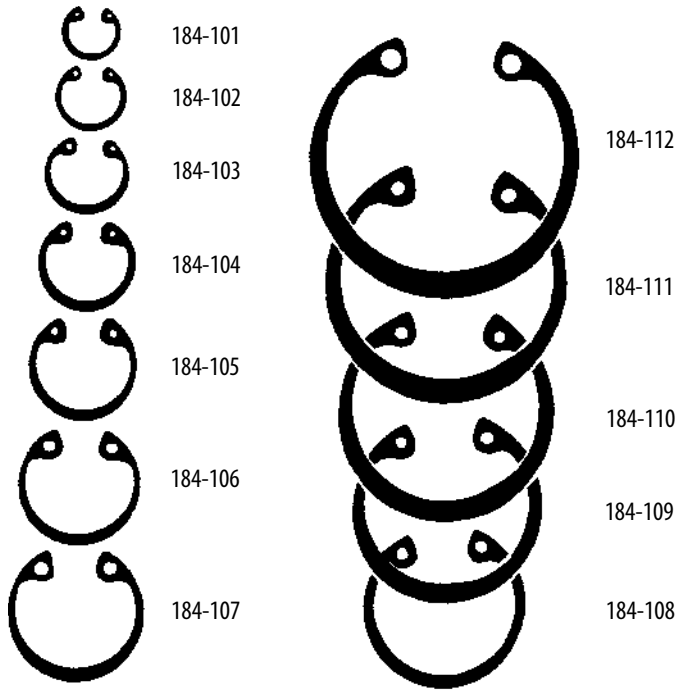

SERIE 185

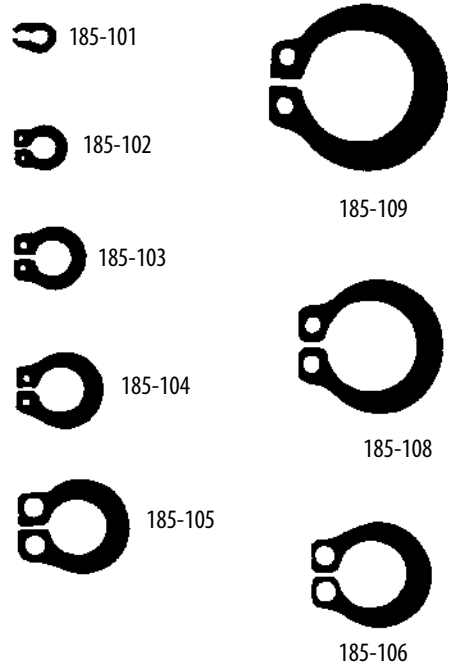

SERIE 187

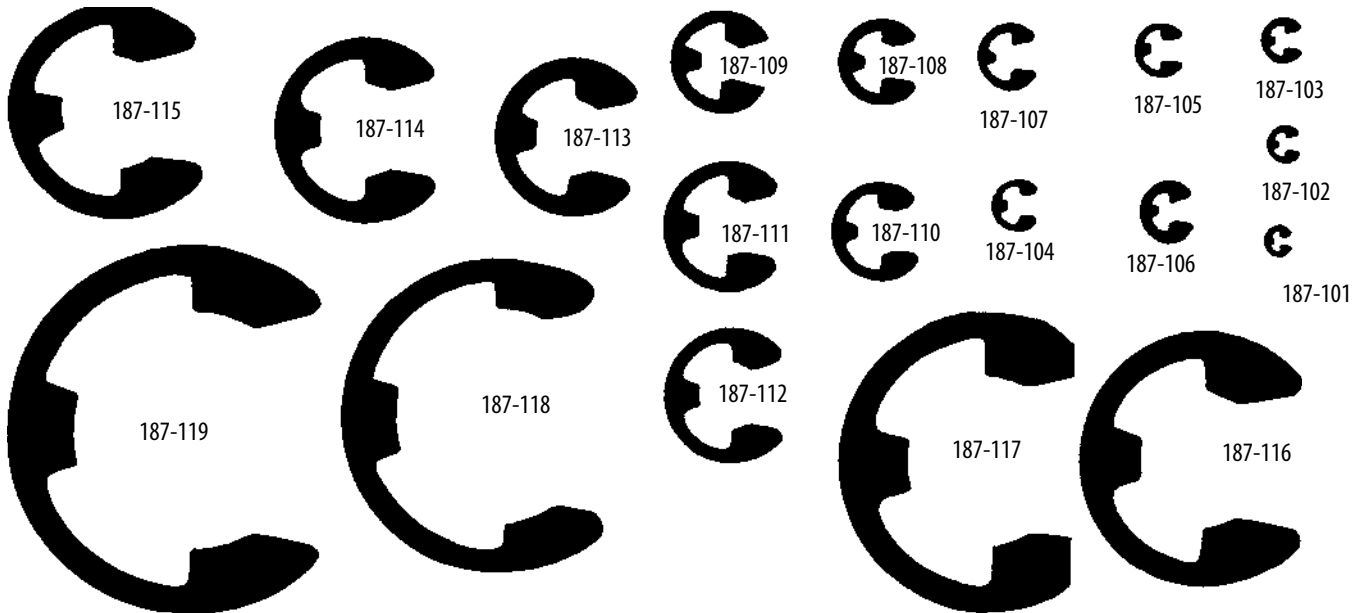

SERIE 183

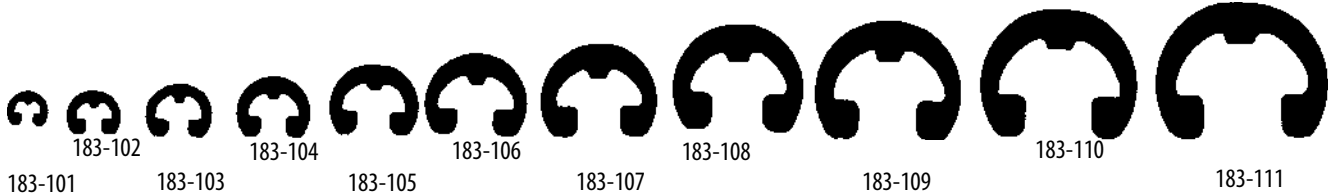

27-10-2023



186-101 186-102 186-103 186-104 186-105 186-106 186-107 186-108 186-109 186-110



186-111 186-112 186-113 186-114 186-115 186-116

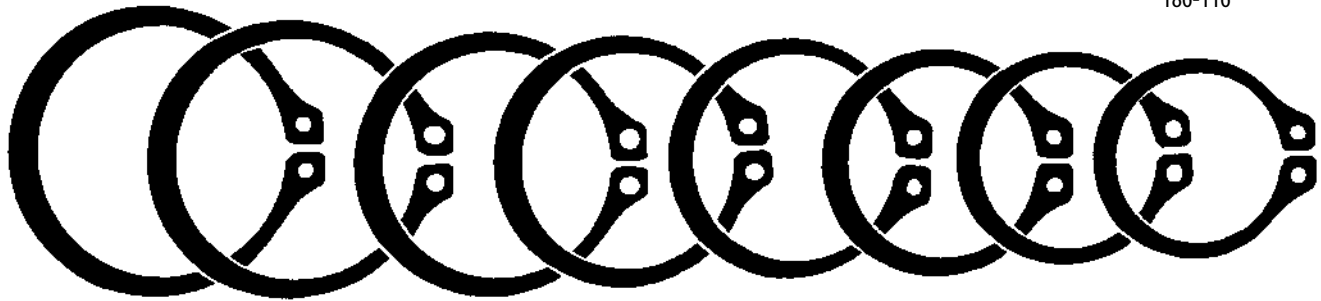

186-150 186-140 186-122 186-121 186-120 186-119 186-118 186-117

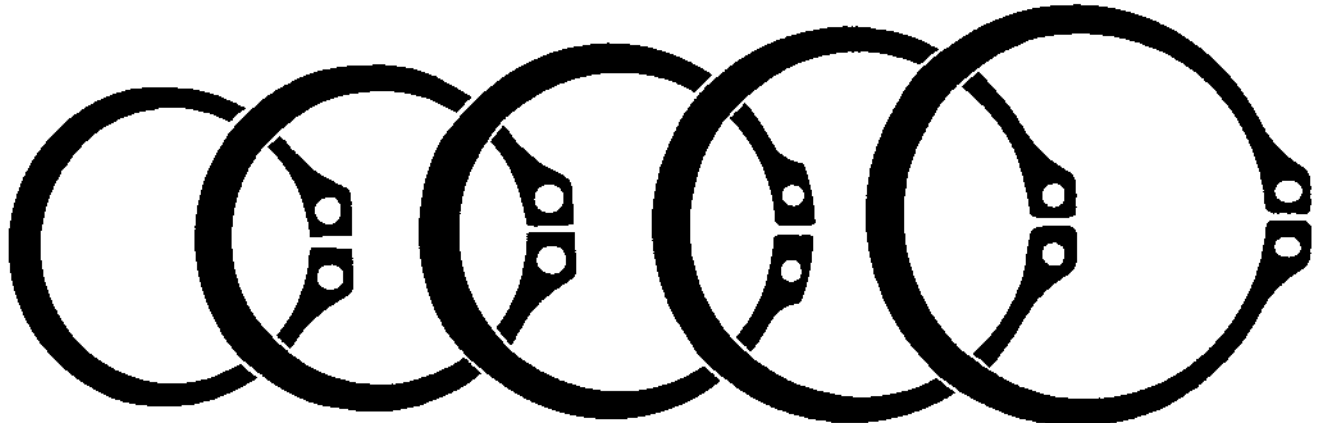

186-123 186-160 186-124 186-166 186-125

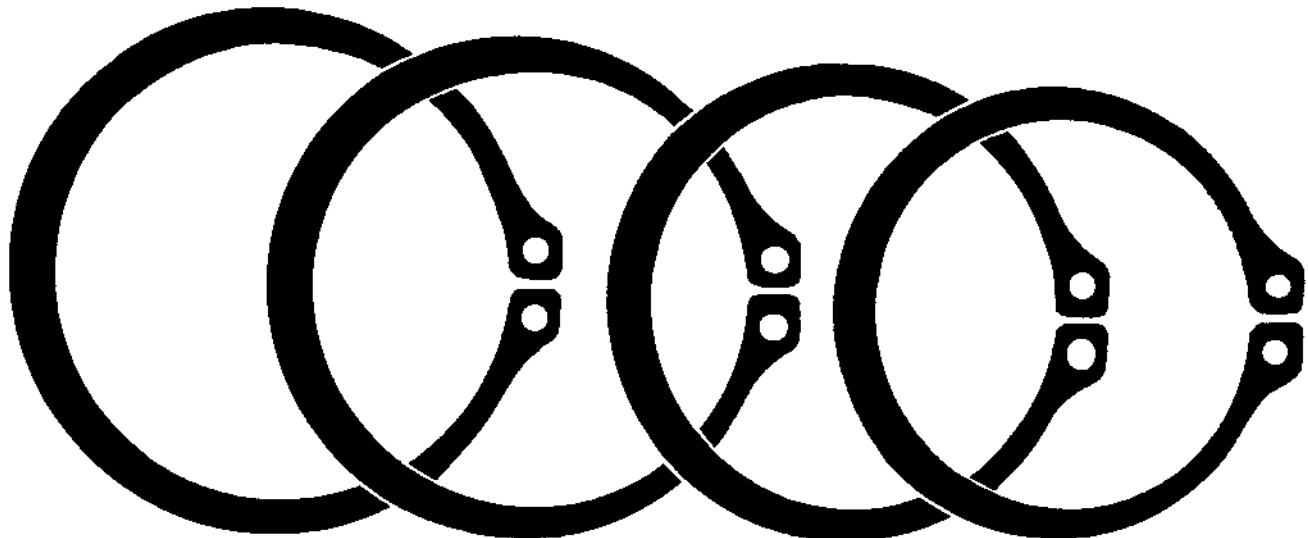

186-127 186-223 186-126 186-167

**BAGUES DE RETENUE
RETAINING RINGS**

SÉRIE 5160 / SHR

EXTÉRIEUR / EXTERNAL



**ÉPAIS
THICK**

NUMÉRO	DIA. TIGE	DIA. FENTE	LARGEUR FENTE	ÉPAIS.	QTE/BTE	NUMÉRO	DIA. TIGE	DIA. FENTE	LARGEUR FENTE	ÉPAIS.	QTE/BTE
185-101	3/32	Non recommandé d'utiliser avec fente			50	185-114	1-1/16	.998	.103	.093	10
185-102	1/8	Not recommended to be use			50	185-115	1-1/8	1.059	.103	.093	10
185-103	3/16	with groove			50	185-116	1-3/16	1.111	.103	.093	10
185-104	1/4	.240	.041	.005	50	185-117	1-1/4	1.174	.103	.093	10
185-105	5/16	.303	.048	.005	50	185-118	1-5/16	1.234	.103	.093	10
185-106	3/8	.361	.048	.007	50	185-119	1-3/8	1.291	.103	.093	10
185-107	7/16	.419	.056	.009	50	185-120	1-1/2	1.406	.120	.109	10
185-108	1/2	.468	.056	.050	25	185-121	1-9/16	1.468	.120	.109	10
185-109	5/8	.588	.056	.050	25	185-122	1-3/4	1.650	.120	.109	10
185-110	21/32	.629	.056	.050	10	185-123	1-15/16	1.826	.139	.125	10
185-111	3/4	.704	.086	.078	10	185-124	2	1.880	.139	.125	10
185-112	7/8	.821	.086	.078	10						
185-113	1	.938	.086	.078	10						

**BAGUES DE RETENUE
RETAINING RINGS**

SÉRIE R1200 / 5144 / RE

EXTÉRIEUR / EXTERNAL

TYPE RE



NUMÉRO BTE	DIA. TIGE	DIA. FENTE	LARGEUR FENTE	ÉPAIS.	QTE/ BTE
183-101	3/32	.074	.020	.015	100
183-102	1/8	.095	.020	.015	100
183-103	5/32	.116	.029	.025	100
183-104	3/16	.147	.029	.025	100
183-105	7/32	.188	.029	.025	100
183-106	1/4	.210	.029	.025	100
183-107	5/16	.250	.029	.025	50
183-108	3/8	.303	.039	.035	50
183-109	7/16	.343	.039	.035	50
183-110	1/2	.396	.046	.042	25
183-111	9/16	.437	.046	.042	25

Résistance plus grande que normal à la vibration et aux chocs
For greater-than-normal resistance to vibration or heavy shock loads.

**BAGUES DE RETENUE
RETAINING RINGS**

SÉRIE R1000 / 5133 / E

EXTÉRIEUR / EXTERNAL

TYPE E



NUMÉRO BTE	DIA. TIGE	DIA. FENTE	LARGEUR FENTE	ÉPAIS.	QTE/ BTE
187-101	1/16	.052	.012	.010	100
187-102	3/32	.074	.020	.015	100
187-103	1/8	.095	.020	.015	100
187-104	9/64	.105	.029	.025	100
187-105	5/32	.116	.029	.025	100
187-106	11/64	.127	.029	.025	100
187-107	3/16	.147	.029	.025	100
187-108	7/32	.188	.029	.025	100
187-109	1/4	.210	.029	.025	100
187-110	5/16	.250	.029	.025	50
187-111	3/8	.303	.039	.035	50
187-112	7/16	.343	.039	.035	50
187-113	1/2	.396	.046	.042	25
187-114	5/8	.485	.046	.042	10
187-115	3/4	.625	.056	.050	10
187-116	7/8	.675	.056	.050	10
187-117	1	.835	.056	.050	10
187-118	1-3/16	1.079	.068	.062	10
187-119	1-3/8	1.230	.068	.062	10

Tous ces produits sont aussi disponible en acier inoxydable / All products also available in stainless steel

GOUILLES FENDUES "HAMMER-LOK" COTTER PINS

ACIER / STEEL



SPÉCIFICATIONS COTTER PINS						
Pin Diameter	Shank Diameter		Wire Width		Head Diameter	
	A		B		C	
	Max.	Min.	Max.	Min.	Min.	Hole Size
1/16	.060	.056	.060	.044	.12	5/64
5/64	.076	.072	.076	.057	.16	3/32
3/32	.090	.086	.090	.069	.19	7/64
7/64	.104	.100	.104	.080	.22	1/8
1/8	.120	.116	.120	.093	.25	9/64
5/32	.150	.146	.150	.116	.31	11/64
3/16	.176	.172	.176	.137	.38	13/64
1/4	.225	.220	.225	.176	.50	17/64
5/16	.280	.275	.280	.220	.62	5/16
3/8	.335	.329	.335	.263	.75	3/8

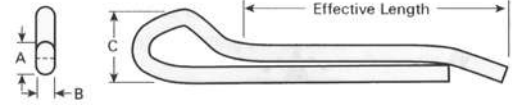
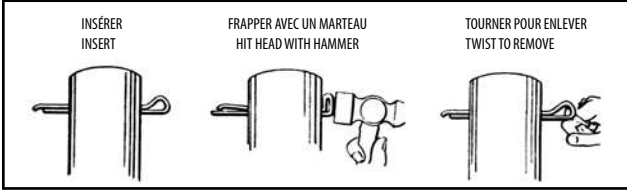

NUMÉRO	DIMENSION	BTE	NUMÉRO	DIMENSION	BTE	NUMÉRO	DIMENSION	BTE			
PLAQUÉ	MÉTAL NU	1/32	PLAQUÉ	MÉTAL NU	5/64 Suite	PLAQUÉ	MÉTAL NU	1/8 Suite			
195-230	195-332	1/32 x 1/4	200	195-251	195-354	5/64 x 1-3/4	200	195-110	195-146	1/8 x 1	200
195-231	195-333	1/32 x 1/2	200	195-252	195-355	5/64 x 2	200	195-111	195-147	1/8 x 1-1/4	200
195-232	195-334	1/32 x 3/4	200	195-253	195-356	5/64 x 2-1/4	200	195-112	195-148	1/8 x 1-1/2	200
195-233	195-335	1/32 x 1	200	195-254	195-357	5/64 x 2-1/2	200	195-113	195-372	1/8 x 1-3/4	200
-	195-336	1/32 x 1-1/4	200	195-255	195-358	5/64 x 3	200	195-114	195-149	1/8 x 2	200
-	195-337	1/32 x 1-1/2	200			3/32		195-269	195-150	1/8 x 2-1/4	200
		3/64		195-256	195-135	3/32 x 1/2	200	195-115	195-151	1/8 x 2-1/2	200
195-234	195-338	3/64 x 1/4	200	195-257	195-359	3/32 x 5/8	200	195-200	195-373	1/8 x 3	100
195-235	195-339	3/64 x 1/2	200	195-105	195-136	3/32 x 3/4	200			5/32	
195-236	195-340	3/64 x 3/4	200	195-258	195-360	3/32 x 7/8	200	195-270	195-152	5/32 x 3/4	100
195-237	195-341	3/64 x 1	200	195-106	195-137	3/32 x 1	200	195-116	195-153	5/32 x 1	100
195-238	195-342	3/64 x 1-1/4	200	195-107	195-138	3/32 x 1-1/4	200	195-271	195-154	5/32 x 1-1/4	100
195-239	195-343	3/64 x 1-1/2	200	195-108	195-139	3/32 x 1-1/2	200	195-117	195-155	5/32 x 1-1/2	100
		1/16		195-259	195-140	3/32 x 1-3/4	200	195-272	195-156	5/32 x 1-3/4	100
195-240	195-344	1/16 x 1/4	200	195-109	195-141	3/32 x 2	200	195-118	195-157	5/32 x 2	100
195-101	195-128	1/16 x 1/2	200	195-260	195-142	3/32 x 2-1/4	200	195-273	195-158	5/32 x 2-1/4	100
195-102	195-129	1/16 x 3/4	200	195-443	195-143	3/32 x 2-1/2	200	195-444	195-159	5/32 x 2-1/2	100
195-103	195-130	1/16 x 1	200	195-261	195-361	3/32 x 3	200	195-445	-	5/32 x 3	100
195-441	195-131	1/16 x 1-1/4	200			7/64		195-205	195-374	5/32 x 3-1/2	100
195-104	195-132	1/16 x 1-1/2	200	195-262	195-362	7/64 x 1/2	200	195-274	195-375	5/32 x 4	100
195-241	-	1/16 x 1-3/4	200	195-263	195-363	7/64 x 3/4	200			3/16	
195-442	-	1/16 x 2	200	195-210	195-364	7/64 x 1	200	195-275	195-161	3/16 x 3/4	100
195-242	195-345	1/16 x 2-1/2	200	195-264	195-365	7/64 x 1-1/4	200	195-276	-	3/16 x 1	100
195-243	195-346	1/16 x 3	200	195-211	195-366	7/64 x 1-1/2	200	195-277	195-163	3/16 x 1-1/4	100
		5/64		195-265	195-367	7/64 x 1-3/4	200	195-119	195-164	3/16 x 1-1/2	100
195-244	195-347	5/64 x 1/2	200	195-212	195-368	7/64 x 2	200	195-278	-	3/16 x 1-3/4	100
195-245	195-348	5/64 x 5/8	200	195-266	195-369	7/64 x 2-1/4	200	195-120	195-166	3/16 x 2	100
195-246	195-349	5/64 x 3/4	200	195-213	195-370	7/64 x 2-1/2	200	195-279	195-167	3/16 x 2-1/4	100
195-247	195-350	5/64 x 7/8	200	195-214	195-371	7/64 x 3	200	195-121	195-168	3/16 x 2-1/2	100
195-248	195-351	5/64 x 1	200			1/8		195-446	195-169	3/16 x 3	100
195-249	195-352	5/64 x 1-1/4	200	195-267	-	1/8 x 1/2	200	195-447	195-170	3/16 x 3-1/2	100
195-250	195-353	5/64 x 1-1/2	200	195-268	195-145	1/8 x 3/4	200	195-448	195-171	3/16 x 4	100

NOTE: LES GOUILLES DE DIAMÈTRE 7/16, 1/2, 5/8 & 3/4 SONT À POINTES BISAUTÉES



GOUPILLES FENDUES "HAMMER-LOK" COTTER PINS

ACIER / STEEL



SPÉCIFICATIONS COTTER PINS						
Pin Diameter	Shank Diameter		Wire Width		Head Diameter	
	A Max.	Min.	B Max.	Min.	C Min.	Hole Size
1/16	.060	.056	.060	.044	.12	5/64
5/64	.076	.072	.076	.057	.16	3/32
3/32	.090	.086	.090	.069	.19	7/64
7/64	.104	.100	.104	.080	.22	1/8
1/8	.120	.116	.120	.093	.25	9/64
5/32	.150	.146	.150	.116	.31	11/64
3/16	.176	.172	.176	.137	.38	13/64
1/4	.225	.220	.225	.176	.50	17/64
5/16	.280	.275	.280	.220	.62	5/16
3/8	.335	.329	.335	.263	.75	3/8

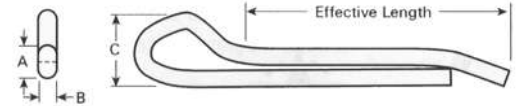

NUMÉRO			DIMENSION			BTE		
PLAQUÉ	MÉTAL NU	7/32	PLAQUÉ	MÉTAL NU	5/16 Suite	PLAQUÉ	MÉTAL NU	1/2
195-280	195-376	7/32 x 1	195-452	195-184	5/16 x 2	195-196	195-417	1/2 x 2
195-281	195-377	7/32 x 1-1/4	195-300	195-394	5/16 x 2-1/4	195-197	195-418	1/2 x 2-1/2
195-282	195-378	7/32 x 1-1/2	195-126	195-185	5/16 x 2-1/2	195-198	195-419	1/2 x 3
195-283	195-379	7/32 x 1-3/4	195-127	195-186	5/16 x 3	195-199	195-420	1/2 x 3-1/2
195-284	195-380	7/32 x 2	195-453	195-187	5/16 x 3-1/2	195-204	195-421	1/2 x 4
195-285	195-381	7/32 x 2-1/4	195-454	195-188	5/16 x 4	195-201	195-422	1/2 x 5
195-286	195-382	7/32 x 2-1/2	195-189	195-395	5/16 x 5	195-202	195-423	1/2 x 6
195-287	195-383	7/32 x 3	195-301	195-396	5/16 x 6	195-316	195-424	1/2 x 7
195-288	195-384	7/32 x 3-1/2			3/8	195-317	195-425	1/2 x 8
195-289	195-385	7/32 x 4	195-302	195-397	3/8 x 1-1/2			5/8
195-290	195-386	7/32 x 4-1/2	195-303	195-398	3/8 x 1-3/4	195-318	195-426	5/8 x 3
195-291	195-387	7/32 x 5	195-190	195-399	3/8 x 2	195-319	195-427	5/8 x 3-1/2
195-292	195-388	7/32 x 6	195-304	195-400	3/8 x 2-1/4	195-320	195-428	5/8 x 4
		1/4	195-455	195-401	3/8 x 2-1/2	195-321	195-429	5/8 x 5
195-293	195-172	1/4 x 1	195-191	195-402	3/8 x 3	195-322	195-223	5/8 x 6
195-294	195-173	1/4 x 1-1/4	195-192	195-403	3/8 x 3-1/2	195-323	195-430	5/8 x 7
195-122	195-174	1/4 x 1-1/2	195-193	195-404	3/8 x 4	195-324	195-431	5/8 x 8
195-295	195-175	1/4 x 1-3/4	195-194	195-405	3/8 x 5			3/4
195-123	195-176	1/4 x 2	195-195	195-406	3/8 x 6	195-325	195-432	3/4 x 3
195-439	195-440	1/4 x 2-1/4	195-305	195-407	3/8 x 7	195-326	195-433	3/4 x 3-1/2
195-124	195-177	1/4 x 2-1/2	195-306	195-456	3/8 x 8	195-327	195-434	3/4 x 4
195-125	195-178	1/4 x 3			7/16	195-328	195-435	3/4 x 5
195-449	195-179	1/4 x 3-1/2	195-307	195-408	7/16 x 2	195-329	195-436	3/4 x 6
195-450	195-180	1/4 x 4	195-308	195-409	7/16 x 2-1/2	195-330	195-437	3/4 x 7
195-451	195-389	1/4 x 4-1/2	195-309	195-410	7/16 x 3	195-331	195-438	3/4 x 8
195-215	195-390	1/4 x 5	195-310	195-411	7/16 x 3-1/2			
195-391	195-392	1/4 x 6	195-311	195-412	7/16 x 4			
		5/16	195-312	195-413	7/16 x 5			
195-296	195-181	5/16 x 1	195-313	195-414	7/16 x 6			
195-297	195-182	5/16 x 1-1/4	195-314	195-415	7/16 x 7			
195-298	195-183	5/16 x 1-1/2	195-315	195-416	7/16 x 8			
195-299	195-393	5/16 x 1-3/4						

Aussi disponible en assortiment divers. Contactez votre représentant pour plus de détails.



27-10-2023

NOTE: LES GOUPILLES DE DIAMÈTRE 7/16, 1/2, 5/8 & 3/4 SONT À POINTES BISAUTÉES

AGRAFES POUR GOUPILLES D'ATTELAGE
HITCH PIN CLIPS

PLAQUÉ ZINC / ZINC PLATED

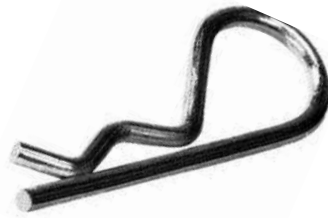

NUMÉRO	CABLE DIA.	TROU FORET	MINIMUM SHAFT DIA.	MAXIMUM SHAFT DIA.	LONG	INSIDE DIA.OEIL	BTE
191-164	.028	1/32	1/8	5/32	.600	.093	100
191-165	.032	.040	7/64	9/64	7/16	.078	100
191-166	.042	.047	1/16	1/8	7/16	.080	100
191-152	.042	3/64	3/16	1/4	1	1/4	100
191-167	.047	1/16	1/8	3/16	19/32	1/8	100
191-110	.047	1/16	1/4	3/8	1-9/16	5/16	100
191-168	.054	1/16	3/16	1/4	3/4	1/8	100
191-169	.054	1/16	1/4	3/8	7/8	9/64	100
191-102	.062	5/64	1/4	1/2	1-5/16	5/16	100
191-170	.062	5/64	3/8	1/2	1-9/16	3/8	100
191-115	.072	5/64	5/16	3/8	1-3/32	9/64	100
191-171	.072	5/64	3/8	1/2	1-7/8	5/8	100
191-116	.080	3/32	1/4	3/8	1-3/16	1/4	100
191-101	.080	3/32	3/8	1/2	1-9/16	3/8	100
191-109	.093	7/64	1/4	1/2	1-5/8	3/8	50
191-104	.093	7/64	1/4	5/8	2-5/16	5/8	50
191-172	.093	7/64	1/4	1/2	2	5/8	50
191-153	.093	7/64	3/8	3/4	2-1/2	9/16	50
191-173	.093	7/64	1/4	1/2	1-1/8	1/4	50
191-174	.105	1/8	5/16	3/8	1-1/4	1/8	50
191-175	.125	9/64	1/2	3/4	1-9/16	1/2	50
191-176	.125	9/64	1/2	3/4	1-15/16	7/16	50
191-105	.125	9/64	7/16	3/4	2-9/16	9/16	25
191-177	.125	9/64	5/8	7/8	2-1/2	5/8	25
191-178	.125	9/64	3/4	1-1/8	2-7/8	5/8	25
191-154	.125	9/64	3/4	1-1/8	3-1/8	1	25
191-155	.148	5/32	1/2 x 5/8	5/8 x 1	3	1/2	25
191-151	.148	5/32	3/4	1-1/8	3-5/16	3/4	25
191-117	.148	5/32	5/8	1	2-15/16	3/4	25
191-149	.162	3/16	7/8	1-1/16	2-3/16	7/8	10
191-160	.162	3/16	1/2 x 3/4	5/8 x 1	3	5/8	10
191-150	.162	3/16	1/2 x 1	7/8 x 1	3-7/16	7/8	10
191-106	.177	3/16	3/4	1-1/16	3-1/2	15/16	10
191-161	.177	3/16	5/8	1	3-1/4	15/16	10
191-156	.177	3/16	7/8	1-1/4	3-3/4	15/16	10
191-108	.243	17/64	3/4	1	4	15/16	10
191-162	.243	17/64	1-1/4	1-1/2	5-1/8	1-1/2	5
191-163	.250	17/64	3/4	1	3-1/4	3/4	5
191-107	.310	21/64	7/8	1	4-1/16	7/8	5

AGRAFES POUR GOUPILLES D'ATTELAGE HITCH PIN CLIPS

PLAQUÉ ZINC / ZINC PLATED

ORDRE NUMÉRIQUE
REGARD RAPIDE pages 12 & 13

NUMÉRO	TROU FORET	LONGUEUR
191-101	3/32	1-9/16
191-102	5/64	1-5/16
191-104	7/64	2-5/16
191-105	9/64	2-9/16
191-106	3/16	3-1/2
191-107	21/64	4-1/16
191-108	17/64	4
191-109	7/64	1-5/8
191-110	1/16	1-9/16
191-115	5/64	1-3/32
191-116	3/32	1-3/16
191-117	5/32	2-15/16
191-149	3/16	2-3/16
191-150	3/16	3-7/16
191-151	5/32	3-5/16
191-152	3/64	1
191-153	7/64	2-1/2
191-154	9/64	3-1/8
191-155	5/32	3
191-156	3/16	3-3/4
191-160	3/16	3
191-161	3/16	3-1/4
191-162	17/64	5-1/8
191-163	17/64	3-1/4
191-164	1/32	.600
191-165	.040	7/16
191-166	.047	7/16
191-167	1/16	19/32
191-168	1/16	3/4
191-169	1/16	7/8
191-170	5/64	1-9/16
191-171	5/64	1-7/8
191-172	7/64	2
191-173	7/64	1-1/8
191-174	1/8	1-1/4
191-175	9/64	1-9/16
191-176	9/64	1-15/16
191-177	9/64	2-1/2
191-178	9/64	2-7/8

GRANDEUR RÉELLE / ACTUAL SIZE

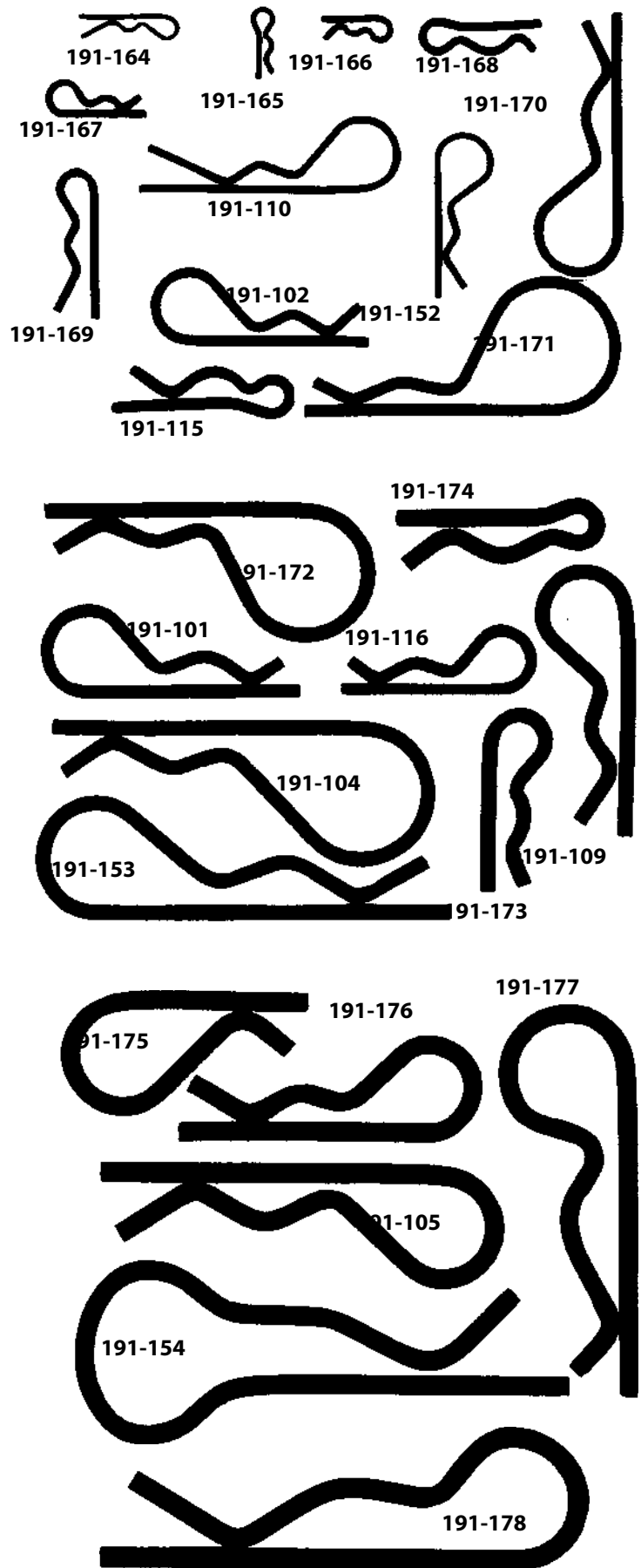

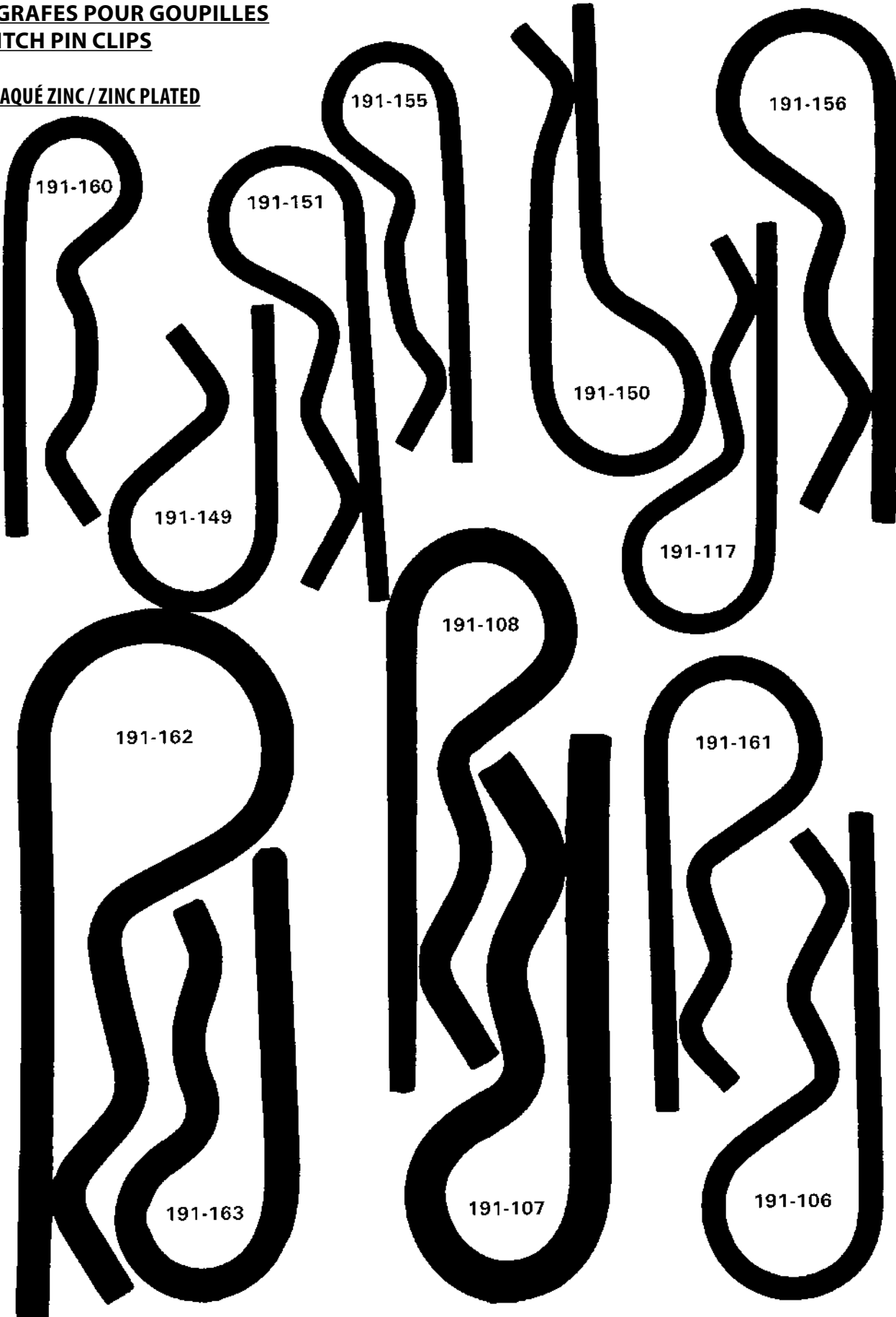

GRANDEUR RÉELLE / ACTUAL SIZE

AGRAFES POUR GOUPILLES D'ATTELAGE "GRIP" GRIP CLIPS

PLAQUÉ ZINC / ZINC PLATED

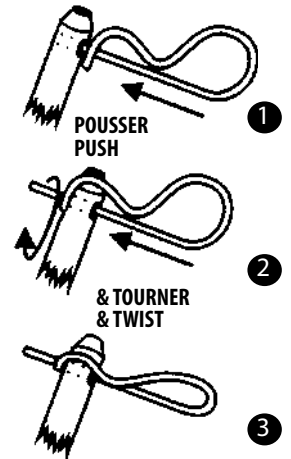
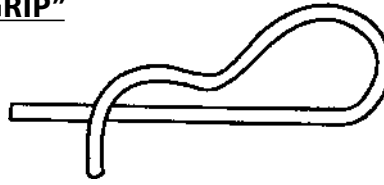

NUMÉRO	DIAMÈTRE TIGE	DIMENSION DU MANCHE RECOMMANDE	LONGUEUR	ID DE L'OEIL	BTE
191-180	.125	3/8 - 5/8	2	7/16	25
191-181	.125	7/16 - 3/4	2-9/16	9/16	25
191-182	.148	5/8 - 1	2-3/4	3/4	25
191-183	.177	7/8 - 1-1/4	3-3/4	15/16	25

AGRAFES DE SÉCURITÉ / SAFETY PIN FASTENERS

PLAQUÉ ZINC / ZINC PLATED

STANDARD / STANDARD

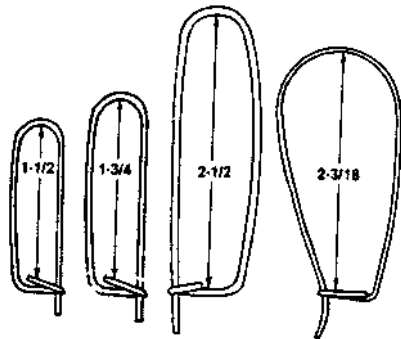

NUMÉRO	DIA. TIGE	DIMENSION	BTE
191-200	.047	1-1/2	50
191-201	.047	1-3/4	50
191-202	.062	2-1/2	50
191-203	.047	2-3/16	50

ROBUSTE / HEAVY DUTY

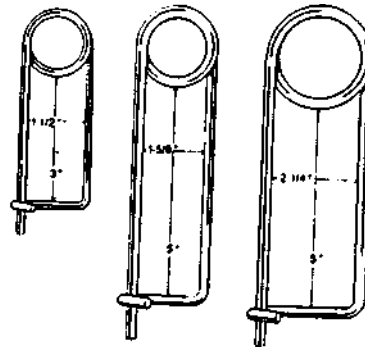

NUMÉRO	DIA. TIGE	DIMENSION	BTE
191-113	.177	1-1/2 x 3	25
191-204	.243	1-5/8 x 5	25
191-205	.243	2-1/4 x 5	25
191-206	.091	1-11/16	25
191-207	.120	2-3/4	25

AGRAFES À DOUBLE BOUCLE / QUALITÉ SUPÉRIEURE DOUBLE LOOP HAIRPIN COTTER / HIGH QUALITY

PLAQUÉ ZINC / ZINC PLATED



NUMÉRO	DIA. TIGE	LONGUEUR	UTILISER SURTIGE	BTE
194-220	3 mm (.118)	3.00	5/8 - 3/4	25
194-221	4 mm (.158)	3.31	7/8 - 1	25

27-10-2023

AGRAFES À ANNEAUX "RUE©" RUE© RING LOCKING COTTERS

- FACILE À UTILISER / EASY ON - OFF
- DOUBLE MÉCANISME DE BARRURE / DOUBLE LOCKING MECHANISM
- RÉUTILISABLE / REUSABLE

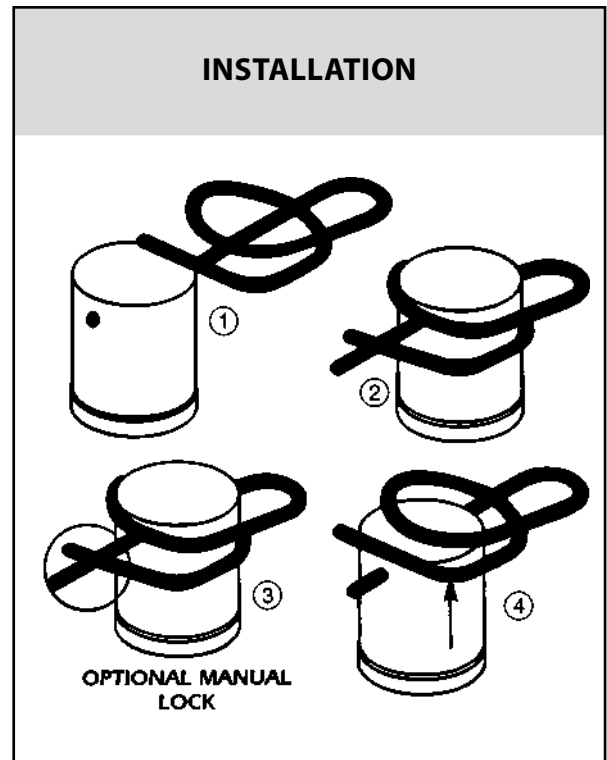
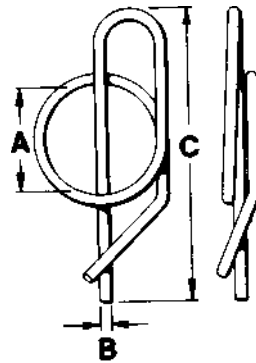

PLAQUÉ ZINC / ZINC PLATED

NUMÉRO	DIMENSION	DIAMETRE CABLE	Dimensions			BTE
			A	B	C	
194-108	1/4	0.041	.267 / .257	.041	.844	50
194-108A	1/4 Heavy	0.054	.270 / .260	.054	.936	50
194-109	5/16	0.047	.330 / .320	.047	1.044	50
194-110	3/8	0.054	.392 / .382	.054	1.214	50
194-113	1/2	0.062	.520 / .510	.062	1.420	25
194-113A	1/2 Heavy	0.072	.520 / .510	.072	1.456	25
194-114	5/8	0.072	.645 / .635	.072	1.690	25
194-115	3/4	0.080	.770 / .760	.080	2.081	10
194-115A	3/4 Heavy	0.091	.770 / .760	.091	2.166	10
194-115B	7/8 Heavy	0.105	.895 / .885	.105	2.506	10
194-117	1	0.105	1.020 / 1.010	.105	2.756	10

ACIER INOXYDABLE / STAINLESS STEEL



NUMÉRO	DIMENSION	DIAMETRE CABLE	Dimensions			BTE
			A	B	C	
194-108AI	1/4	0.041	.267 / .257	.041	.844	50
194-109AI	5/16	0.047	.330 / .320	.047	1.044	50
194-110AI	3/8	0.054	.392 / .382	.054	1.214	50
194-113AI	1/2 Heavy	0.072	.520 / .510	.072	1.456	25
194-114AI	5/8	0.072	.645 / .635	.072	1.690	25
194-115AI	3/4 Heavy	0.091	.770 / .760	.091	2.166	10

27-10-2023

AGRAFES À BARRURE "BOW-TIE" BOW-TIE® LOCKING COTTERS

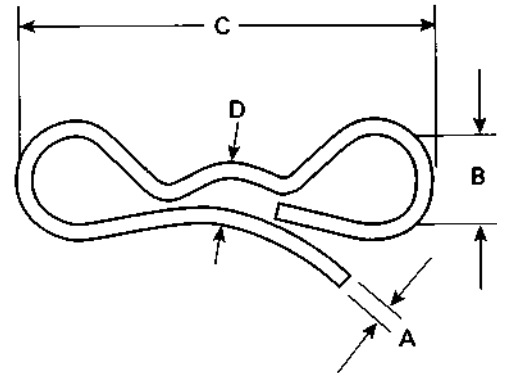
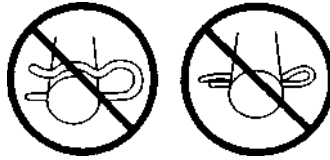

INSTALLATION / INSTALL

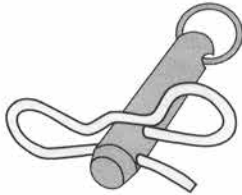

Pour installer, pousser ou tirer
Bow-Tie® dans la goupille
To install push on pull Bow-Tie® into hole.

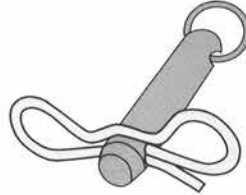

Une fois installé, le Bow-Tie® reste barré en
tension zéro.
Bow-Tie® snaps into a zero-tension locked
position.

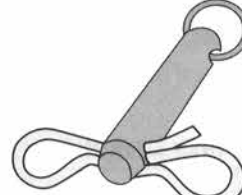

Le Bow-Tie® peut être inversé et reste barré en
tension zéro.
The Bow-Tie® can be flipped over the end...and
stays locked



Pour retirer le Bow-Tie®, tirer et lever.
Pull locking loop up and over to release.

PLAQUÉ ZINC / ZINC PLATED

NUMÉRO	DIMENSION	RECOMMANDÉ	A	B	C	D	BTE
194-210	1/4 5/16 3/8	0.094 0.094 0.156	0.072	0.250	1.375	0.260	50
194-211	5/16 3/8	0.109 0.125	0.091	0.375	1.875	0.305	50
194-212	7/16 1/2	0.141 0.156	0.120	0.583	2.750	0.430	50
194-213	5/8	0.156	.0120	0.562	2.750	0.490	25
194-214	5/8	0.203	0.148	0.687	3.578	0.540	25
194-215	3/4	0.156	0.120	0.562	2.750	0.545	25
194-216	3/4	0.203	0.148	0.687	3.578	0.600	25
194-217	1	0.218	0.177	0.875	4.578	0.762	25

AGRAFES À BARRURE "BOW-TIE®" / BOW-TIE® LOCKING COTTER S

194-210
Fits 1/4" - 3/8"



194-211
Fits 5/16" - 3/8"



194-212
Fits 7/16" - 1/2"



194-213
Fits 5/8"



194-214
Fits 5/8"



194-215
Fits 3/4"



194-216
Fits 3/4"

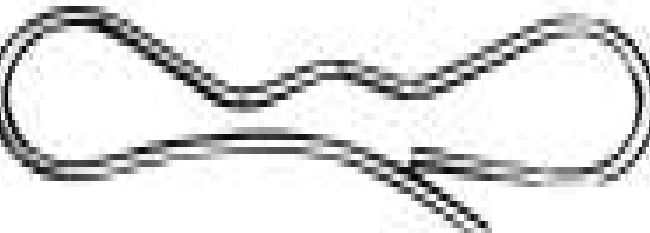

194-217
Fits 1"

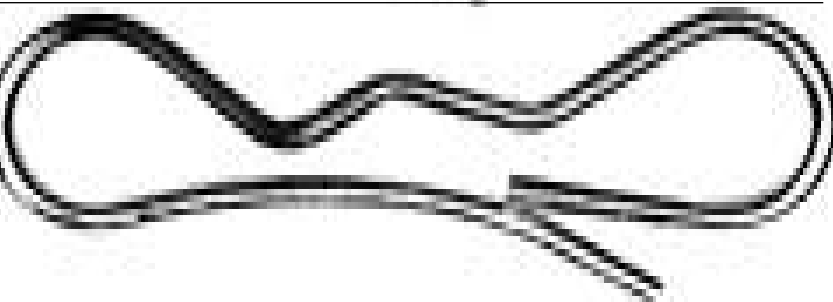

GRANDEUR RÉELLE APPROXIMATIVE / APPROXIMATE ACTUAL SIZE

CROCHETS EN "S" INFINI INFINITY "S" HOOK

- CONNEXION RAPIDE / QUICK CONNECTOR
- FACILE À UTILISER / EASY ON / OFF
- SÉCURITAIRE / SECURE
- SANS OUTILS NÉCESSAIRE / NO TOOLS NEEDED
- RÉUTILISABLE / REUSABLE



NUMÉRO	DIMENSION			BTE
	A	B	C	
194-222	0.12	2-5/8"	0.66	25

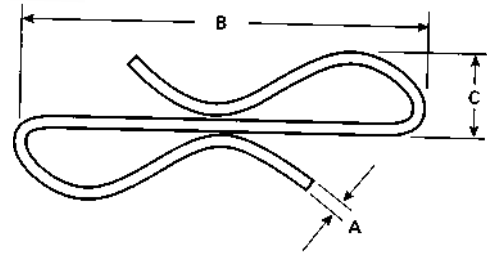

CROCHETS EN "S" "S" HOOKS

PLAQUÉ ZINC / ZINC PLATED

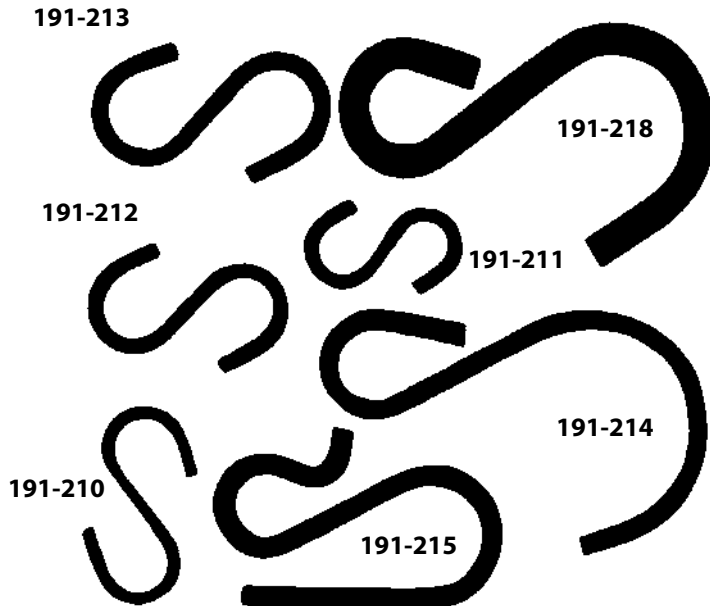

NUMÉRO	TIGE	LONG	BTE
191-210	.080	1-1/16	100
191-211	0.93	7/8	100
191-212	.105	1-3/32	100
191-213	.120	1-5/16	100
191-214	.120	2-1/8	100
191-215	.135	1-9/16	50
191-216	.148	2	50
191-217	.162	1-7/16	50
191-218	.177	2	50
191-219	.177	2-7/8	50
191-220	.188	2-7/8	50
191-221	.250	2-1/2	50
191-222	.250	3	25
191-223	.305	3-5/8	25
191-224	.312	2-5/8	25
191-225	.375	3-1/4	25
191-226	.375	4-5/8	25

VOIR SHÉMA CI-CONTRE POUR GRANDEUR RÉELLE

**GRANDEUR RÉELLE
ACTUAL SIZE**

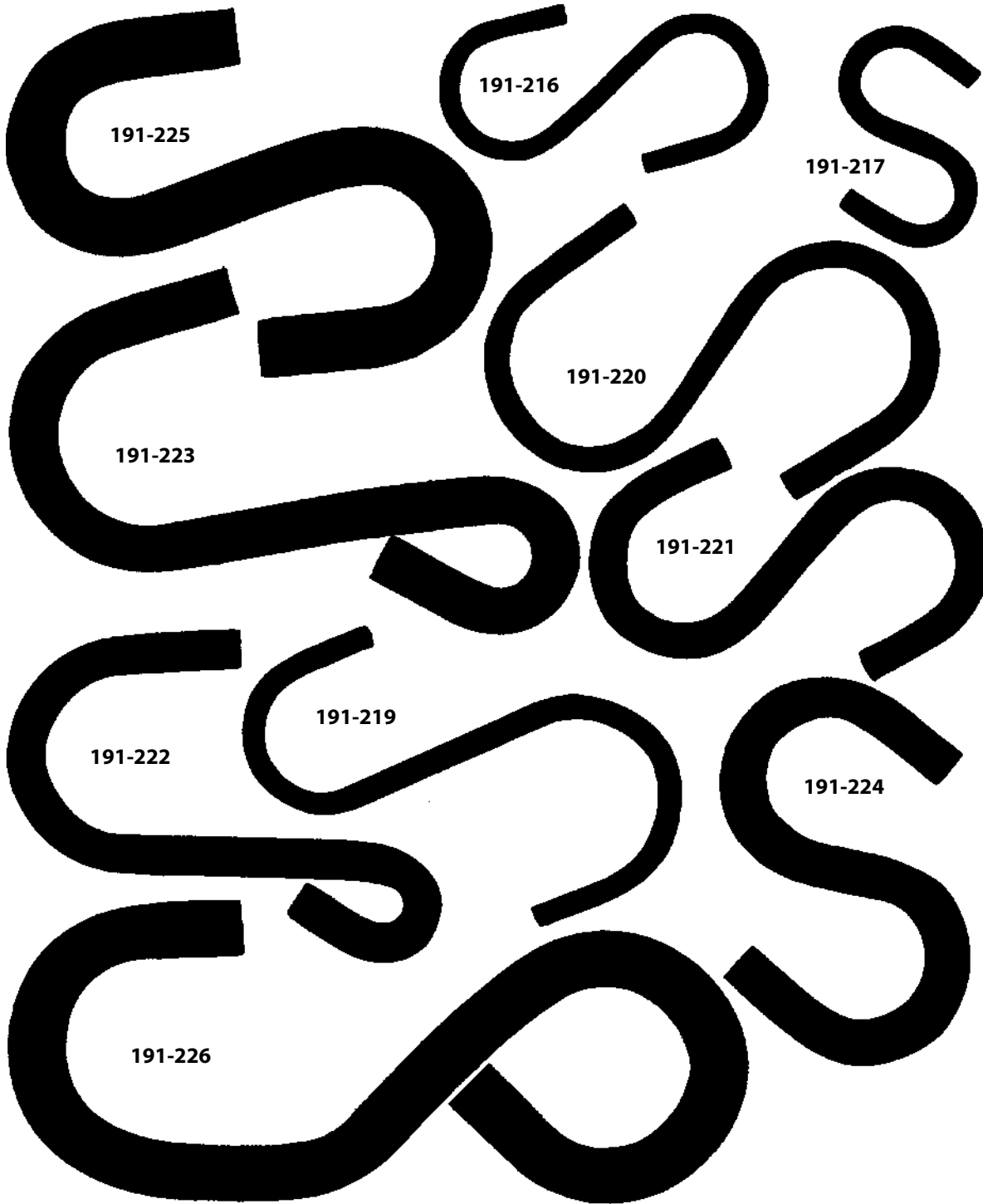

GRANDEUR RÉELLE / ACTUAL SIZE



**GOUPILLES À AXE DE CHAPE
AJUSTABLE
CLEVIS PINS**

ACIER / STEEL

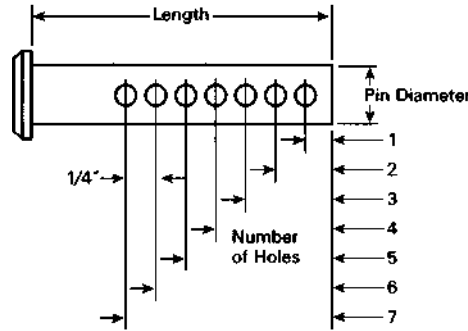

SPÉCIFICATIONS GOUPILLES À AXE DE CHAPE AJUSTABLE / ADJUSTABLE CLEVIS PINS			
Distance entre le centre des trous est de 1/4"			
	Goup. Dia. 3/16 à 1/4	Goup. Dia. 5/16	Goup. Dia. 3/8 à 5/8
Dim. 1	3/32	1/8	5/32
Dim. 2	11/32	3/8	13/32
Dim. 3	19/32	5/8	21/32
Dim. 4	27/32	7/8	29/32
Dim. 5	1-3/32	1-1/8	1-5/32
Dim. 6	1-11/32	1-3/8	1-13/32
Dim. 7	1-19/32	1-5/8	1-21/32
Trous	3/32	1/8	5/32

NUMÉRO	DIMENSION		NOMBRE	TROUS TROUS	DIA. TÊTE X	DIA. TIGE	BTE	TOLÉRANCE		
								ÉPAISSEUR		
3/16										
196-230	3/16	x	1-1/2	5	3/32	5/16	x	1/16	.186 à .181	10
196-231	3/16	x	2	5	3/32	5/16	x	1/16	.186 à .181	10
1/4										
196-232	1/4	x	1	3	3/32	3/8	x	3/32	.248 à .243	10
196-233	1/4	x	1-1/2	5	3/32	3/8	x	3/32	.248 à .243	10
196-116	1/4	x	2	5	3/32	3/8	x	3/32	.248 à .243	10
196-234	1/4	x	2-1/2	5	3/32	3/8	x	3/32	.248 à .243	10
196-235	1/4	x	3	7	3/32	3/8	x	3/32	.248 à .243	10
5/16										
196-236	5/16	x	1	3	1/8	7/16	x	3/32	.311 à .306	10
196-237	5/16	x	1-1/2	4	1/8	7/16	x	3/32	.311 à .306	10
196-117	5/16	x	2	5	1/8	7/16	x	3/32	.311 à .306	10
196-238	5/16	x	2-1/2	5	1/8	7/16	x	3/32	.311 à .306	10
196-239	5/16	x	3	7	1/8	7/16	x	3/32	.311 à .306	10
3/8										
196-240	3/8	x	1-1/2	4	5/32	1/2	x	1/8	.373 à .368	10
196-118	3/8	x	2	5	5/32	1/2	x	1/8	.373 à .368	10
196-241	3/8	x	2-1/2	5	5/32	1/2	x	1/8	.373 à .368	10
196-242	3/8	x	3	7	5/32	1/2	x	1/8	.373 à .368	10
196-243	3/8	x	4	7	5/32	1/2	x	1/8	.373 à .368	10
7/16										
196-119	7/16	x	2	5	5/32	9/16	x	5/32	.436 à .431	10
196-121	7/16	x	2-1/2	5	5/32	9/16	x	5/32	.436 à .431	10
196-244	7/16	x	3	7	5/32	9/16	x	5/32	.436 à .431	10
196-245	7/16	x	4	7	5/32	9/16	x	5/32	.436 à .431	10
1/2										
196-120	1/2	x	2	5	5/32	5/8	x	5/32	.496 à .491	10
196-122	1/2	x	2-1/2	7	5/32	5/8	x	5/32	.496 à .491	10
196-123	1/2	x	3	7	5/32	5/8	x	5/32	.496 à .491	10
196-246	1/2	x	4	7	5/32	5/8	x	5/32	.496 à .491	10
5/8										
196-247	5/8	x	2	5	5/32	13/16	x	13/64	.621 à .616	10
196-124	5/8	x	3	7	5/32	13/16	x	13/64	.621 à .616	10
196-248	5/8	x	4	7	5/32	13/16	x	13/64	.621 à .616	10

27-10-2023



GOUPILLES À AXE DE CHAPE CLEVIS PINS

ACIER / STEEL

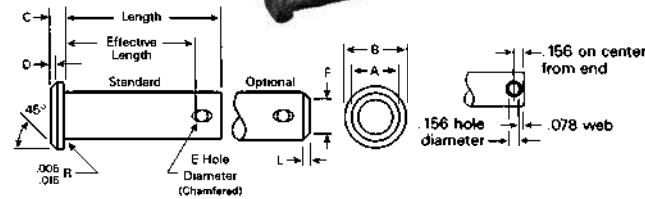

SPÉCIFICATIONS GOUPILLES À AXE DE CHAPE / CLEVIS PINS

Basic Shank Diameter	Shank Dia.		Head Dia.		Head Height	Head/Pivot Point Chamfer Std. Hole		Optimal Dimensions Per J493		
	A	B	C	D		E	Hole Dia. E	Point Dia. F	Point Length L	
3/16	.186	.181	.31	.06	.02	3/32	5/64	.14	.045	
1/4	.248	.243	.37	.09	.03	3/32	5/64	.20	.045	
5/16	.311	.306	.43	.09	.03	1/8	7/64	.25	.060	
3/8	.373	.368	.50	.12	.03	5/32	7/64	.32	.060	
7/16	.436	.431	.56	.15	.04	5/32	7/64	.38	.060	
1/2	.496	.491	.62	.15	.04	5/32	9/64	.43	.076	
5/8	.621	.616	.81	.20	.06	5/32	9/64	.55	.076	
3/4	.746	.741	.93	.25	.07	5/32	11/64	.67	.093	

NUMÉRO	DIMENSION			TO EDGE OF HOLE	TO CENTER OF HOLE	HOLE	BTE
196-002	3/16	x	1/2	0.359	0.406	3/32	50
196-004	3/16	x	19/32	0.453	0.500	3/32	50
196-006	3/16	x	5/8	0.484	0.531	3/32	50
196-008	3/16	x	3/4	0.609	0.656	3/32	50
196-010	3/16	x	7/8	0.734	0.781	3/32	50
196-012	3/16	x	1	0.859	0.906	3/32	50
196-014	3/16	x	1-1/4	1.109	1.156	3/32	50
196-016	3/16	x	1-1/2	1.359	1.406	3/32	50
196-018	3/16	x	1-3/4	1.609	1.656	3/32	50
196-020	3/16	x	2	1.859	1.906	3/32	50
196-022	3/16	x	2-1/2	2.359	2.406	3/32	50
196-024	3/16	x	3	2.859	2.906	3/32	50
196-026	1/4	x	1/2	0.359	0.406	3/32	50
196-028	1/4	x	5/8	0.484	0.531	3/32	50
196-030	1/4	x	3/4	0.609	0.656	3/32	50
196-088	1/4	x	51/64	0.656	0.703	3/32	50
196-034	1/4	x	7/8	0.734	0.781	3/32	50
196-101	1/4	x	1	0.859	0.906	3/32	50
196-102	1/4	x	1-1/8	0.984	1.031	3/32	50
196-040	1/4	x	1-1/4	1.109	1.156	3/32	50
196-152	1/4	x	1-3/8	1.234	1.281	3/32	50
196-044	1/4	x	1-1/2	1.359	1.406	3/32	50
196-153	1/4	x	1-5/8	1.484	1.531	3/32	50
196-048	1/4	x	1-3/4	1.609	1.656	3/32	50
196-050	1/4	x	1-7/8	1.734	1.781	3/32	50
196-052	1/4	x	2	1.859	1.906	3/32	50
196-054	1/4	x	2-1/8	1.984	2.031	3/32	50
196-056	1/4	x	2-1/4	2.109	2.156	3/32	50
196-062	1/4	x	2-1/2	2.359	2.406	3/32	50
196-066	1/4	x	2-3/4	2.609	2.656	3/32	50
196-068	1/4	x	3	2.859	2.906	3/32	50
196-070	1/4	x	3-1/2	3.359	3.406	3/32	25
196-072	1/4	x	4	3.859	3.906	3/32	25

NUMÉRO	DIMENSION			TO EDGE OF HOLE	TO CENTER OF HOLE	HOLE	BTE
196-076	5/16	x	1/2	0.313	0.375	1/8	50
196-078	5/16	x	3/4	0.563	0.625	1/8	50
196-080	5/16	x	7/8	0.688	0.750	1/8	50
196-082	5/16	x	31/32	0.781	0.844	1/8	50
196-103	5/16	x	1	0.813	0.875	1/8	50
196-104	5/16	x	1-1/8	0.938	1.000	1/8	50
196-089	5/16	x	1-3/16	1.000	1.063	1/8	50
196-105	5/16	x	1-1/4	1.063	1.125	1/8	50
196-106	5/16	x	1-3/8	1.188	1.250	1/8	50
196-106A	5/16	x	1-1/2	1.313	1.375	1/8	50
196-107	5/16	x	1-3/4	1.563	1.625	1/8	50
196-090	5/16	x	1-7/8	1.688	1.750	1/8	50
196-091	5/16	x	2	1.813	1.875	1/8	50
196-092	5/16	x	2-1/8	1.938	2.000	1/8	50
196-093	5/16	x	2-1/4	2.063	2.125	1/8	50
196-094	5/16	x	2-3/8	2.188	2.250	1/8	50
196-095	5/16	x	2-1/2	2.313	2.375	1/8	50
196-165	5/16	x	2-5/8	2.438	2.500	1/8	50
196-166	5/16	x	2-3/4	2.563	2.625	1/8	50
196-167	5/16	x	3	2.813	2.875	1/8	50
196-168	5/16	x	3-1/2	3.313	3.375	1/8	25
196-169	5/16	x	4	3.813	3.875	1/8	25
196-170	3/8	x	3/4	0.516	0.594	5/32	50
196-108	3/8	x	1	0.766	0.844	5/32	50
196-171	3/8	x	1-3/32	0.859	0.938	5/32	50
196-109	3/8	x	1-1/8	0.891	0.969	5/32	50
196-111	3/8	x	1-1/4	1.016	1.094	5/32	50
196-172	3/8	x	1-5/16	1.078	1.156	5/32	50
196-173	3/8	x	1-3/8	1.141	1.219	5/32	50
196-112	3/8	x	1-1/2	1.266	1.344	5/32	50
196-174	3/8	x	1-5/8	1.391	1.469	5/32	50
196-113	3/8	x	1-3/4	1.516	1.594	5/32	50
196-175	3/8	x	1-7/8	1.640	1.719	5/32	50



GOUPILLES À AXE DE CHAPE CLEVIS PINS

ACIER / STEEL

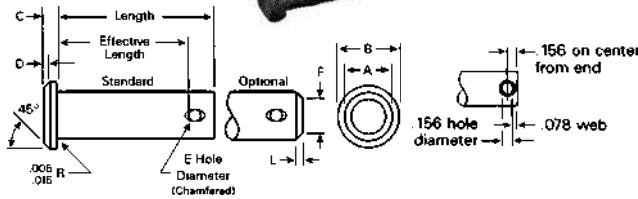

SPÉCIFICATIONS GOUPILLES À AXE DE CHAPE / CLEVIS PINS											
Basic Shank Diameter	Shank Dia.		Head Dia.		Head Height		Head Pivot Point Chamfered Hole		Optimal Dimensions Per J493		
	A	B	C	D	E	F	L	Hole Dia.	Point Dia.	Point Length	
3/16	.186	.181	.31	.06	.02	3/32	5/64	.14	.045		
1/4	.248	.243	.37	.09	.03	3/32	5/64	.20	.045		
5/16	.311	.306	.43	.09	.03	1/8	7/64	.25	.060		
3/8	.373	.368	.50	.12	.03	5/32	7/64	.32	.060		
7/16	.436	.431	.56	.15	.04	5/32	7/64	.38	.060		
1/2	.496	.491	.62	.15	.04	5/32	9/64	.43	.076		
5/8	.621	.616	.81	.20	.06	5/32	9/64	.55	.076		
3/4	.746	.741	.93	.25	.07	5/32	11/64	.67	.093		

NUMÉRO	DIMENSION		TO EDGE OF HOLE	TO CENTER OF HOLE	HOLE	BTE
196-149	3/8	x 2	1.766	1.844	5/32	50
196-177	3/8	x 2-1/8	1.891	1.969	5/32	25
196-178	3/8	x 2-1/4	2.016	2.094	5/32	25
196-179	3/8	x 2-3/8	2.141	2.219	5/32	25
196-180	3/8	x 2-1/2	2.266	2.344	5/32	25
196-181	3/8	x 2-5/8	2.391	2.469	5/32	25
196-182	3/8	x 2-3/4	2.516	2.594	5/32	25
196-183	3/8	x 3	2.766	2.844	5/32	25
196-144	3/8	x 3-1/4	3.016	3.094	5/32	25
196-185	3/8	x 3-1/2	3.266	3.344	5/32	25
196-186	3/8	x 3-3/4	3.516	3.594	5/32	25
196-187	3/8	x 4	3.766	3.844	5/32	25
196-161	7/16	x 1	0.766	0.844	5/32	25
196-188	7/16	x 1-15/64	1.000	1.078	5/32	25
196-189	7/16	x 1-1/4	1.016	1.094	5/32	25
196-190	7/16	x 1-1/2	1.266	1.344	5/32	25
196-132	7/16	x 1-3/4	1.516	1.594	5/32	25
196-191	7/16	x 2	1.766	1.844	5/32	25
196-192	7/16	x 2-1/4	2.016	2.094	5/32	25
196-193	7/16	x 2-1/2	2.266	2.344	5/32	25
196-194	7/16	x 3	2.766	2.844	5/32	25
196-195	7/16	x 3-1/2	3.266	3.344	5/32	10
196-196	7/16	x 4	3.766	3.844	5/32	10
196-162	1/2	x 1	0.766	0.844	5/32	25
196-126	1/2	x 1-1/4	1.016	1.094	5/32	25
196-197	1/2	x 1-27/64	1.188	1.266	5/32	25
196-114	1/2	x 1-1/2	1.266	1.344	5/32	25
196-115	1/2	x 1-3/4	1.516	1.594	5/32	25
196-127	1/2	x 2	1.766	1.844	5/32	25
196-198	1/2	x 2-1/4	2.016	2.094	5/32	25
196-199	1/2	x 2-1/2	2.266	2.344	5/32	25

NUMÉRO	DIMENSION		TO EDGE OF HOLE	TO CENTER OF HOLE	HOLE	BTE
196-200	1/2	x 2-5/8	2.391	2.469	5/32	25
196-148	1/2	x 2-3/4	2.516	2.594	5/32	25
196-163	1/2	x 3	2.766	2.844	5/32	25
196-202	1/2	x 3-1/2	3.266	3.344	5/32	10
196-203	1/2	x 4	3.766	3.844	5/32	10
196-204	1/2	x 4-1/2	4.266	4.344	5/32	10
196-205	1/2	x 5	4.766	4.844	5/32	10
196-206	5/8	x 1-1/4	1.016	1.094	5/32	25
196-164	5/8	x 1-1/2	1.266	1.344	5/32	25
196-207	5/8	x 1-3/4	1.516	1.594	5/32	25
196-208	5/8	x 2	1.766	1.844	5/32	25
196-209	5/8	x 2-1/4	2.016	2.094	5/32	25
196-210	5/8	x 2-1/2	2.266	2.344	5/32	25
196-211	5/8	x 3	2.766	2.844	5/32	10
196-212	5/8	x 3-1/2	3.266	3.344	5/32	10
196-213	5/8	x 4	3.766	3.844	5/32	10
196-214	3/4	x 2	.766	1.844	5/32	10
196-215	3/4	x 2-1/2	2.266	2.344	5/32	10
196-217	3/4	x 3	2.766	2.844	5/32	10
196-220	3/4	x 4	3.766	3.844	5/32	10

Aussi disponible en assortiment divers. Contactez votre représentant pour plus de détails



27-10-2023



**GOUILLES À AXE DE CHAPE
CLEVIS PINS**

ACIER INOXYDABLE 302 / STAINLESS STEEL 302

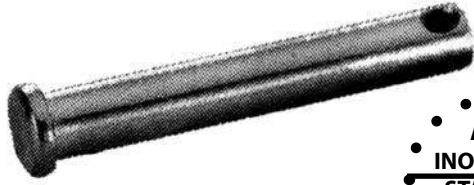

**ACIER
INOXYDABLE
STAINLESS
STEEL**

LONGUEUR APPROX.
SOUS LA TÊTE

SPÉCIFICATIONS GOUILLES À AXE DE CHAPE / CLEVIS PINS										
Basic Shank Diameter	Shank Dia.		Head Dia.		Head Height	Head Chamfer	Pivot Point Std. Hole	Optimal Dimensions Per J493		
	A	B	C	D	E	F	E	F	L	
3/16	.186	.181	.31	.06	.02	3/32	5/64	.14	.045	
1/4	.248	.243	.37	.09	.03	3/32	5/64	.20	.045	
5/16	.311	.306	.43	.09	.03	1/8	7/64	.25	.060	
3/8	.373	.368	.50	.12	.03	5/32	7/64	.32	.060	
7/16	.436	.431	.56	.15	.04	5/32	7/64	.38	.060	
1/2	.496	.491	.62	.15	.04	5/32	9/64	.43	.076	
5/8	.621	.616	.81	.20	.06	5/32	9/64	.55	.076	
3/4	.746	.741	.93	.25	.07	5/32	11/64	.67	.093	

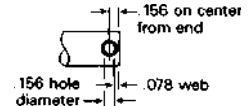
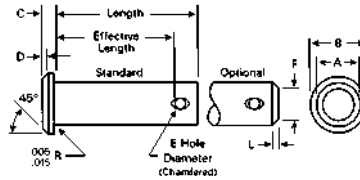

LONGUEUR APPROX.
SOUS LA TÊTE

NUMÉRO	DIMENSION		TO EDGE OF HOLE	TO CENTER OF HOLE	HOLE	BTE
405-210	3/16	x 1/2	0.359	0.406	3/32	50
405-211	3/16	x 5/8	0.484	0.531	3/32	50
405-212	3/16	x 3/4	0.609	0.659	3/32	50
405-213	3/16	x 1	0.859	0.906	3/32	50
405-214	3/16	x 1-1/4	1.109	1.156	3/32	50
405-215	3/16	x 1-1/2	1.359	1.406	3/32	50
405-216	1/4	x 1/2	0.359	0.406	3/32	50
405-217	1/4	x 5/8	0.484	0.531	3/32	50
405-218	1/4	x 3/4	0.609	0.659	3/32	50
405-219	1/4	x 1	0.859	0.906	3/32	50
405-220	1/4	x 1-1/8	0.984	1.031	3/32	50
405-221	1/4	x 1-1/4	1.109	1.156	3/32	50
405-222	1/4	x 1-1/2	1.359	1.406	3/32	50

NUMÉRO	DIMENSION		TO EDGE OF HOLE	TO CENTER OF HOLE	HOLE	BTE
405-223	5/16	x 3/4	0.563	0.625	1/8	50
405-224	5/16	x 1	0.813	0.875	1/8	50
405-225	5/16	x 1-1/4	1.063	1.125	1/8	50
405-226	5/16	x 1-1/2	1.313	1.375	1/8	50
405-227	3/8	x 3/4	0.516	0.594	5/32	50
405-228	3/8	x 1	0.766	0.844	5/32	50
405-229	3/8	x 1-1/4	1.016	1.094	5/32	50
405-230	3/8	x 1-1/2	1.266	1.344	5/32	50

**GOUILLES DE VERROUILLAGE
BENT ARM PINS**

PLAQUÉ ZINC / ZINC PLATED



NUMÉRO	DIMENSION A	B	C	D	BTE
196-330	1/2 x 3	.500	5/32	3/16	3/8 50
196-331	5/8 x 3	.625	3/16	3/16	7/16 50

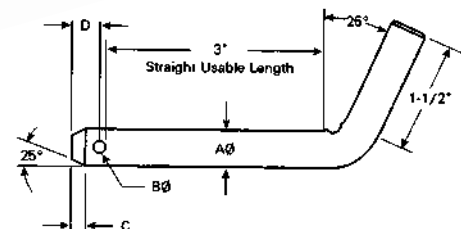

27-10-2023

GOUPILLES D'ATTELAGE AVEC ANNEAUX DETENT RING PINS

PLAQUÉ ZINC/ ZINC PLATED

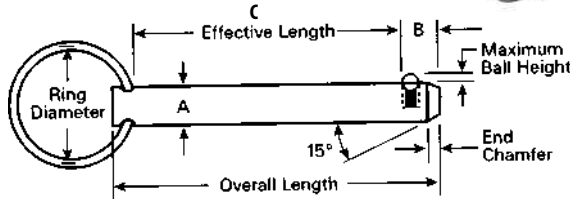

SPÉCIFICATIONS GOUPILLES D'ATTELAGE / DETENT RING PINS			
Diamètre Nominale Goupille A	Diamètre de l'anneau	Fin de Goupille x 15 deg.	
		B	
3/16	7/8	0.078	0.234
1/4	1	0.094	0.281
5/16	1	0.125	0.344
3/8	1	0.141	0.391
7/16	1	0.156	0.438
1/2	1-1/4	0.172	0.484
5/8	1-1/4	0.188	.500 ou .562
3/4	1-1/2	0.188	.563 ou .625

NUMÉRO	DIMENSION A x C	DIA. BILLE	HAUT BILLE	COMP BILLE	BTE	NUMÉRO	DIMENSION A x C	DIA. BILLE	HAUT BILLE	COMP BILLE	BTE
3/16						3/8					
196-250	3/16 x 13/16	3/32	0.028	5	5	196-277	3/8 x 5/8	3/16	0.056	16	5
196-251	3/16 x 1	3/32	0.028	5	5	196-278	3/8 x 3/4	3/16	0.056	16	5
196-252	3/16 x 1-5/16	3/32	0.028	5	5	196-279	3/8 x 1	3/16	0.056	16	5
196-253	3/16 x 1-1/2	3/32	0.028	5	5	196-280	3/8 x 1-1/8	3/16	0.056	16	5
196-254	3/16 x 1-13/16	3/32	0.028	5	5	196-281	3/8 x 1-1/2	3/16	0.056	16	5
196-255	3/16 x 2	3/32	0.028	5	5	196-282	3/8 x 1-5/8	3/16	0.056	16	5
1/4						196-283	3/8 x 2	3/16	0.056	16	5
196-256	1/4 x 3/4	1/8	0.038	9	5	196-284	3/8 x 2-1/8	3/16	0.056	16	5
196-257	1/4 x 1	1/8	0.038	9	5	196-285	3/8 x 2-1/2	3/16	0.056	16	5
196-258	1/4 x 1-1/4	1/8	0.038	9	5	196-286	3/8 x 2-5/8	3/16	0.056	16	5
196-259	1/4 x 1-1/2	1/8	0.038	9	5	196-287	3/8 x 3	3/16	0.056	16	5
194-260	1/4 x 1-3/4	1/8	0.038	9	5	196-288	3/8 x 3-1/8	3/16	0.056	16	5
196-261	1/4 x 2	1/8	0.038	9	5	7/16					
196-262	1/4 x 2-1/4	1/8	0.038	9	5	196-289	7/16 x 1	7/32	0.066	16	5
196-263	1/4 x 2-1/2	1/8	0.038	9	5	196-290	7/16 x 2	7/32	0.066	16	5
196-264	1/4 x 2-3/4	1/8	0.038	9	5	196-291	7/16 x 2-1/16	7/32	0.066	16	5
196-265	1/4 x 3	1/8	0.038	9	5	196-292	7/16 x 2-1/2	7/32	0.066	16	5
5/16						196-293	7/16 x 2-9/16	7/32	0.066	16	5
196-266	5/16 x 5/8	5/32	0.047	12	5	196-294	7/16 x 3	7/32	0.066	16	5
196-267	5/16 x 3/4	5/32	0.047	12	5	1/2					
196-268	5/16 x 1	5/32	0.047	12	5	196-295	1/2 x 1	1/4	0.075	18	5
196-269	5/16 x 1-1/8	5/32	0.047	12	5	196-296	1/2 x 1-1/2	1/4	0.075	18	5
196-270	5/16 x 1-1/2	5/32	0.047	12	5	196-297	1/2 x 2	1/4	0.075	18	5
196-271	5/16 x 1-5/8	5/32	0.047	12	5	196-298	1/2 x 2-1/2	1/4	0.075	18	5
196-272	5/16 x 2	5/32	0.047	12	5	194-200	1/2 x 3	1/4	0.075	18	5
196-273	5/16 x 2-1/8	5/32	0.047	12	5	194-202	1/2 x 4	1/4	0.075	18	5
196-274	5/16 x 2-1/2	5/32	0.047	12	5						
196-275	5/16 x 3	5/32	0.047	12	5						
196-276	5/16 x 3-1/8	5/32	0.047	12	5						

27-10-2023

GOUPILLES DE VERROUILLAGE POSITIVE POSITIVE LOCK PINS

PLAQUÉ ZINC/ ZINC PLATED



SPÉCIFICATIONS GOUPILLES À BARRURE - POSITIVE / POSITIVE LOCK PINS SPECS

Diamètre Goupille A	Hauteur de la bille B		C	D	F	Diamètre de la tête G
1/4 (2455 / 2485)	284	294	.093 x 22°	0.312	0.870	0.700
5/16 (308 / 311)	370	380	.125 x 22°	0.312	0.870	0.800
3/8 (3705 / 3735)	435	445	.125 x 22°	0.375	0.900	0.860
1/2 (4955 / 4985)	589	599	.125 x 22°	0.437	1.125	1.000

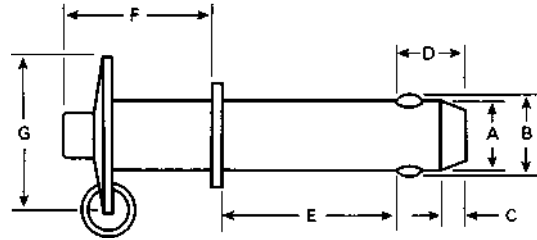

NUMÉRO	DIMENSION		BTE
	A	E	
1/4			
196-340	1/4	x 1/2	5
196-341	1/4	x 3/4	5
196-342	1/4	x 1	5
196-343	1/4	x 1-1/4	5
196-344	1/4	x 1-1/2	5
5/16			
196-345	5/16	x 1	5
196-346	5/16	x 1-1/4	5
196-347	5/16	x 1-1/2	5
196-348	5/16	x 1-3/4	5
196-349	5/16	x 2	5
3/8			
196-350	3/8	x 1	5
196-351	3/8	x 1-1/4	5
196-352	3/8	x 1-1/2	5
196-353	3/8	x 1-3/4	5
196-354	3/8	x 2	5
196-355	3/8	x 2-1/4	5
196-356	3/8	x 2-1/2	5
1/2			
196-357	1/2	x 1	5
196-358	1/2	x 1-1/2	5
196-359	1/2	x 1-3/4	5
196-360	1/2	x 2	5
196-361	1/2	x 2-1/2	5
196-362	1/2	x 3	5
196-363	1/2	x 3-1/2	5

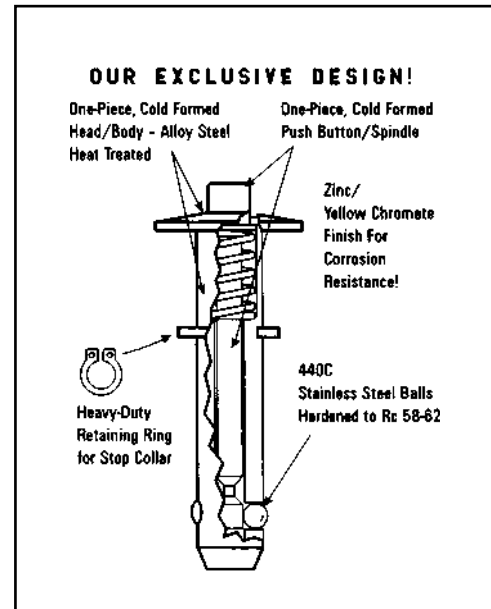

GOUILLES À ANNEAUX - TRACTION PULL PINS

PLAQUÉ ZINC/ ZINC PLATED

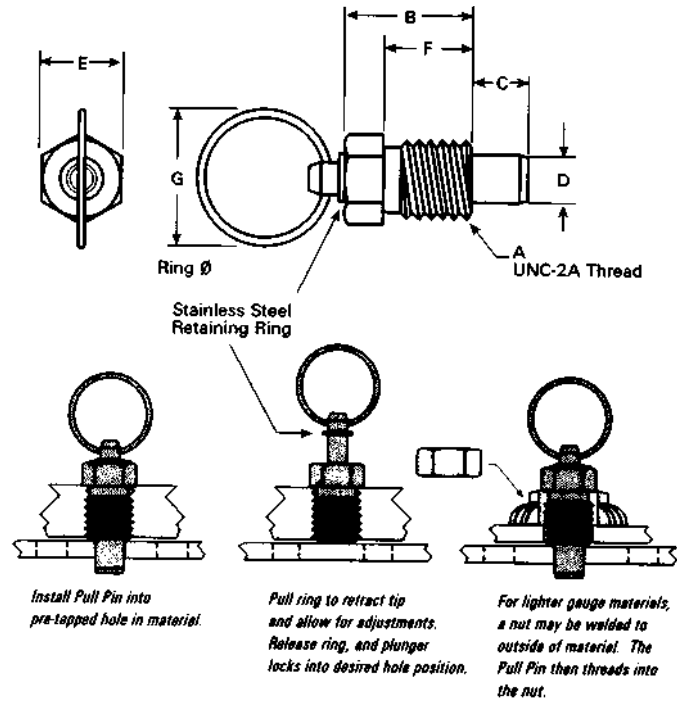

SPÉCIFICATIONS GOUILLES À ANNEAUX
PULL PINS SPECS

NUMÉRO	FILET DIA.	FORCE APPROX. LBS		A	B	C	D	E	F	G	BTE
		INITIAL	FINAL								
196-324	1/4	0.50	2.00	1/4-20	0.44	.19	.16	.25	.31	0.875	5
196-325	3/8	0.75	3.00	3/8-16	0.63	.28	.25	.38	.44	0.875	5
196-326	1/2	1.00	4.00	1/2-13	0.81	.38	.31	.50	.56	1.00	5
196-327	5/8	1.25	5.00	5/8-11	1.00	.44	.38	.62	.69	1.00	5

BILLES PISTON BALL PLUNGERS

NOIR OXYDE/ BLACK OXIDE

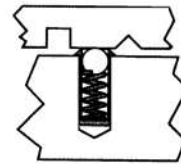
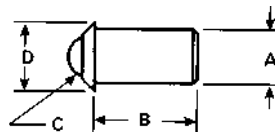

Install Ball Plunger into push-fit hole in material. Spring loaded ball automatically depresses to allow adjustments.

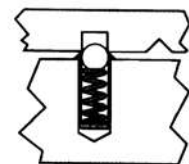

Spring loaded ball then snaps back into the desired hole, groove or indentation.

SPÉCIFICATIONS BILLE PISTON
BALL PLUNGERS SPECS

NUMÉRO	FILET DIA.	FORCE APPROX. LBS		A	B	C	D	BTE
		INITIAL	FINAL					
196-328	1/4	3	7	.250	.471	.187	.312	5
196-329	3/8	5	14	.375	.786	.313	.500	5

27-10-2023

CLAVETTES D'ESSIEU LYNCH PINS

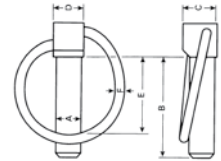

PLAQUÉ ZINC / ZINC PLATED

NUMÉRO	GOUILLE DIA. A	GOUILLE LONGUEUR B	LONGUEUR UTILISABLE E	CÂBLE F	BTE
194-132	3/16	1-1/4	1	.118	10
194-165	3/16	1-9/16	1-5/16	.177	10
194-133	1/4	1-3/4	1-1/4	.138	10
194-105	1/4	1-3/4	1-7/16	.138	10
194-134	5/16	1-9/16	1-1/4	.138	10
194-166	5/16	1-3/4	1-3/8	.138	10
194-135	3/8	1-3/4	1-7/16	.138	10
194-136	7/16	1-9/16	1-11/32	.138	10
194-167	7/16	1-3/4	1-3/8	.138	10
194-137	7/16	1-3/4	1-1/2	.197	10
194-168	7/16	1-15/16	1-11/16	.197	10
194-169	7/16	1-15/16	1-1/2	.197	10

GOUILLES DE VERROUILLAGE WIRE LOCK PINS

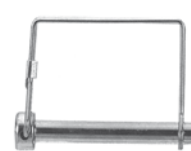
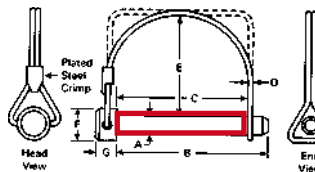

PLAQUÉ ZINC / ZINC PLATED

Type	NUMÉRO	GOUILLE DIAMETRE A	GOUILLE LONGUEUR B	LONGUEUR UTILISABLE C	CÂBLE D	DÉGAGEMENT E	BTE
CARRÉE	194-138	1/4	2-3/4	2-1/2	.091	1.625	5
	194-138B	1/4	2-3/4	2-1/2	.091	1.625	25
	194-138A	1/4	3-1/2	2-1/4	.091		5
	194-139	5/16	2-3/4	2-1/2	.091	1.75	5
	194-140	3/8	2-3/4	2-1/4	.091	1.50	5
	194-141	3/8	2-3/4	2-1/2	.091	1.50	
RONDE	194-142	1/4	1-1/4	1-3/8	.091	1.625	5
	194-143	1/4	2	1-3/4	.091	1.625	5
	194-143A	1/4		3-1/8			5
	194-144	5/16	1-3/4	1-3/8	.091	2.00	5
	194-145	5/16	2-1/8	1-3/4	.091	2.00	5
	194-145A	5/16	2-3/4	2-1/2	.091	2.00	5
	194-146	3/8	1-3/4	1-3/8	.091	1.50	5
	194-146A	3/8		2-3/4	.091		

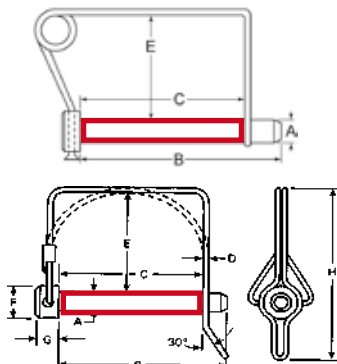

	NUMÉRO	GOUILLE DIAMETRE A	GOUILLE LONGUEUR B	LONGUEUR UTILISABLE C	CÂBLE D	DÉGAGEMENT E	BTE
CARRÉE	194-173	5/16	4-7/16	4	-	2	5
	194-174	1/4	4-7/16	4	-	2	5
RONDE	194-118	1/4	2	1-3/4	.091	1.625	5
	194-119	3/8	2-3/4	2-1/4	.091	1.500	5

**NAUTS DE HAUBAN
NYLON LANYARDS**

NYLON / NYLON

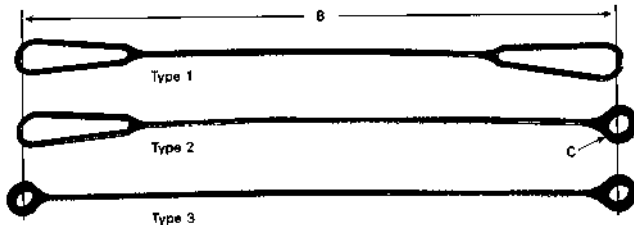

NUMÉRO	DIMENSIONS			TYPE	LBS	B	C	BTE
	DIA.	X	LONG					
196-301	.093	x	6	TYPE 1	35	6.00	N/A	10
196-302	.093	x	8	TYPE 1	35	8.00	N/A	10
196-303	.093	x	12	TYPE 1	35	12.00	N/A	10
196-304	.093	x	6	TYPE 2	35	6.00	.20	10
196-305	.093	x	6	TYPE 2	35	6.00	.26	10
196-306	.093	x	8	TYPE 2	35	8.00	.26	10
196-307	.093	x	10	TYPE 2	35	10.00	.26	10
196-308	.093	x	12	TYPE 2	35	12.00	.26	10
196-309	.093	x	6	TYPE 3	35	6.00	.26	10
196-310	.093	x	8	TYPE 3	35	8.00	.20 & .26	10
196-311	.093	x	8	TYPE 3	35	8.00	.26	10
196-312	.093	x	10	TYPE 3	35	10.00	.20 & .26	10
196-313	.093	x	10	TYPE 3	35	10.00	.26	10
196-314	.093	x	12	TYPE 3	35	12.00	.26	10

**NAUTS DE HAUBAN - STYLE "U"
U-LOCK NYLON LANYARDS**

NYLON / NYLON

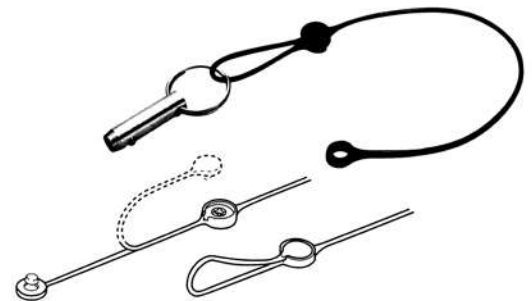

NUMÉRO	TYPE	DIMENSION									LBS	BTE
		A	B	C	D	E	F	G	H	LONG		
196-315	TYPE 1	0.093	8"	4"	.50	--	--	0.34	1.50	10"	35	50
196-316	TYPE 1	0.093	7"	4"	.50	--	--	1.00	2.50	9"	35	50
196-317	TYPE 2	0.093	8"	4"	.50	0.473	0.20	--	--	10"	35	50
196-318	TYPE 2	0.093	8"	4"	.50	0.473	0.26	--	--	10"	35	50

27-10-2023

ÉPINGLES ATTACHE
HAIR PIN CLIPS

PLAQUÉ ZINC / ZINC PLATED

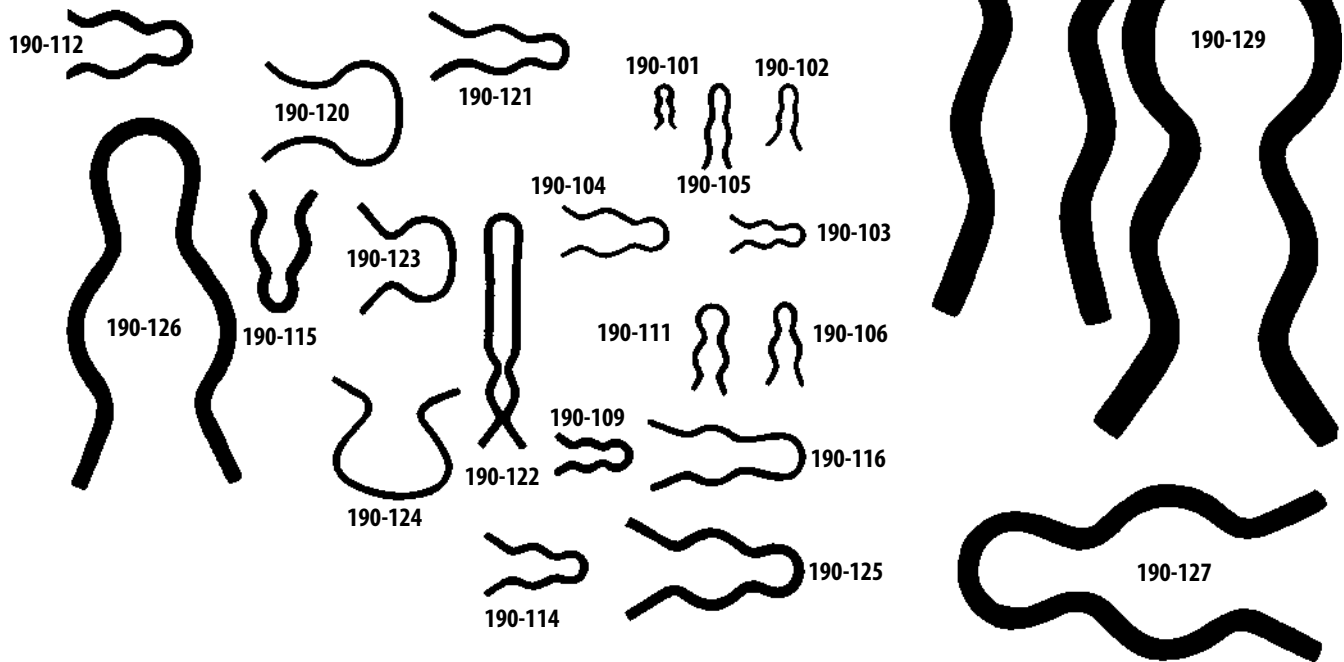
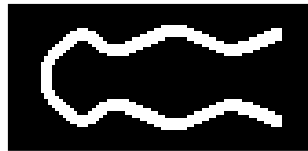

GRANDEUR RÉELLE / ACTUAL SIZE

NUMÉRO	TIGE DIAMÈTRE	OEIL ID	FENTE DIA.	LONG	BTE
190-102	.026	1/16	3/32	3/8	200
190-103	.028	3/32	1/8	7/16	200
190-105	.028	1/16	3/32	1/2	200
190-101	.028	1/16	5/64	9/32	200
190-104	.035	3/32	7/32	5/8	200
190-106	.035	3/32	5/32	15/32	200
190-111	.035	1/8	5/32	1/2	200
190-120	.042	-	-	3/4	200
190-116	.046	3/16	5/16	15/16	200
190-109	.047	3/32	1/8	7/16	200
190-114	.047	7/64	3/16	19/32	200
190-121	.047	1/8	1/4	7/8	200
190-122	.047	1/8	3/16	1-5/16	200
190-123	.047	-	5/16	9/16	200
190-124	.047	-	3/8	5/8	200
190-125	.062	3/16	3/8	1	100
190-115	.062	1/8	1/4	11/16	100
190-112	.062	5/32	5/16	3/4	100
190-126	.105	7/16	25/32	2-1/16	50
190-127	.125	7/16	25/32	2-1/16	50
190-128	.177	3/4	11/16	2-3/4	50
190-129	.187	7/8	3/4	2-7/8	50

27-10-2023

BAGUES DE RETENUE À SERRER CRIMP RING RETAINERS

PLAQUÉ ZINC / ZINC PLATED

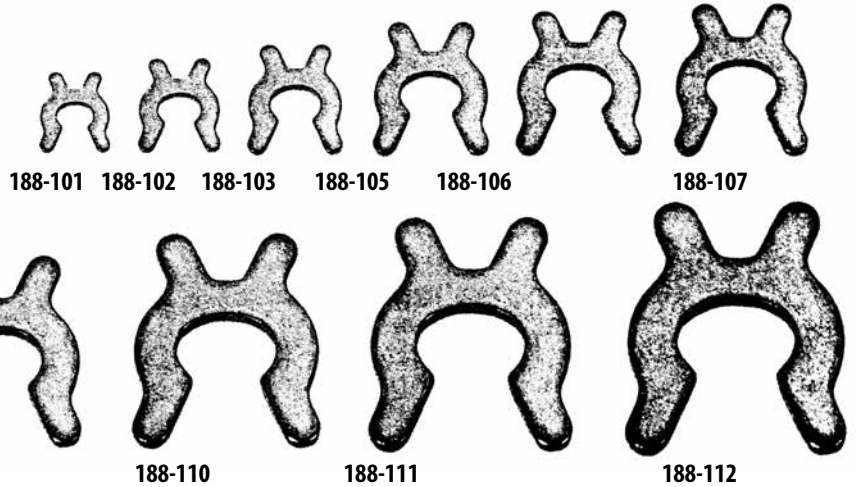
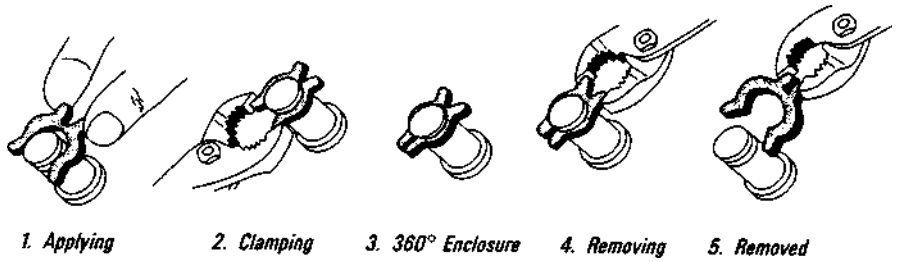
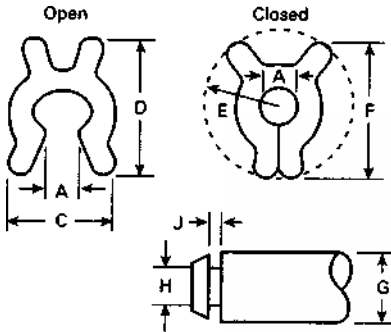

NUMÉRO	A	ÉPAIS.	C	D	E	F	DIMENSION			BTE
							G	H	J	
188-101	0.086	0.025	0.320	0.406	0.210	0.406	5/32	0.086	0.031	50
188-102	0.098	0.055	0.364	0.490	0.297	0.475	3/16	0.093	0.062	50
188-103	0.130	0.055	0.430	0.575	0.359	0.556	1/4	0.125	0.062	50
188-105	0.164	0.065	0.523	0.687	0.422	0.665	5/16	0.156	0.075	50
188-106	0.190	0.065	0.593	0.745	0.437	0.730	3/8	0.187	0.075	25
188-107	0.222	0.075	0.622	0.776	0.469	0.775	7/16	0.218	0.083	25
188-108	0.256	0.075	0.698	0.905	0.500	0.890	1/2	0.250	0.083	25
188-109	0.285	0.075	0.822	0.986	0.563	0.984	9/16	0.279	0.083	25
188-110	0.317	0.089	0.872	1.100	0.609	1.078	5/8	0.311	0.097	25
188-111	0.347	0.089	0.948	1.190	0.688	1.188	11/16	0.341	0.097	25
188-112	0.381	0.089	1.060	1.297	0.797	1.281	3/4	0.375	0.097	10

RIVETS PRESSION PRESS LOCK RIVETS

NYLON / NYLON

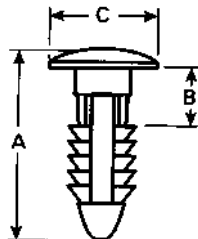

NUMÉRO	DIMENSION TROU	DIMENSION			BTE	
		REQUIS	A	B		C
196-319	1/4 X 5/8	0.250	.625	.125	.500	10
196-320	1/4 X 3/4	0.250	.750	.250	.500	10

27-10-2023

GOUPILLES CYLINDRIQUES DE PRÉCISION PRECISION GROUND DOWEL PINS

RENCONTRE / MEETS SPEC.: ANSI / ASME 18.8.2

ACIER / STEEL - STANDARD ALLOY



SPÉCIFICATIONS
Dureté
Core hardness : C47-58 / Rockwell
Case hardness : C60 min. / Rockwell
Shear strength : 130,000 PSI min.

NUMÉRO	DIMENSION	BTE	NUMÉRO	DIMENSION	BTE	NUMÉRO	DIMENSION	BTE
1/16			1/4			7/16 (suite)		
225-001	1/16 x 3/16	50	225-157	1/4 x 1/2	50	225-307	7/16 x 2	20
225-004	1/16 x 1/4	50	225-160	1/4 x 5/8	50	225-313	7/16 x 2-1/2	20
225-007	1/16 x 5/16	50	225-163	1/4 x 3/4	50	225-319	7/16 x 3	20
225-010	1/16 x 3/8	50	225-166	1/4 x 7/8	50	1/2		
225-013	1/16 x 7/16	50	225-169	1/4 x 1	50	225-322	1/2 x 3/4	20
225-016	1/16 x 1/2	50	225-175	1/4 x 1-1/4	50	225-325	1/2 x 1	20
225-019	1/16 x 5/8	50	225-181	1/4 x 1-1/2	50	225-328	1/2 x 1-1/4	20
225-022	1/16 x 3/4	50	225-184	1/4 x 1-3/4	50	225-331	1/2 x 1-1/2	20
225-025	1/16 x 7/8	50	225-187	1/4 x 2	50	225-334	1/2 x 1-3/4	20
225-028	1/16 x 1	50	225-190	1/4 x 2-1/4	50	225-337	1/2 x 2	20
3/32			225-193	1/4 x 2-1/2	50	225-340	1/2 x 2-1/4	20
225-043	3/32 x 3/16	50	5/16			225-343	1/2 x 2-1/2	20
225-046	3/32 x 1/4	50	225-202	5/16 x 1/2	50	225-349	1/2 x 3	20
225-049	3/32 x 5/16	50	225-205	5/16 x 5/8	50	225-355	1/2 x 3-1/2	20
225-052	3/32 x 3/8	50	225-208	5/16 x 3/4	50	225-361	1/2 x 4	20
225-055	3/32 x 7/16	50	225-211	5/16 x 7/8	50	5/8		
225-058	3/32 x 1/2	50	225-214	5/16 x 1	50	225-364	5/8 x 1	10
225-061	3/32 x 5/8	50	225-220	5/16 x 1-1/4	50	225-367	5/8 x 1-1/4	10
225-064	3/32 x 3/4	50	225-226	5/16 x 1-1/2	50	225-370	5/8 x 1-1/2	10
225-067	3/32 x 7/8	50	225-229	5/16 x 1-3/4	25	225-373	5/8 x 1-3/4	10
225-070	3/32 x 1	50	225-232	5/16 x 2	25	225-376	5/8 x 2	10
1/8			225-235	5/16 x 2-1/4	25	225-379	5/8 x 2-1/4	10
225-085	1/8 x 3/8	50	225-238	5/16 x 2-1/2	25	225-382	5/8 x 2-1/2	10
225-088	1/8 x 1/2	50	225-244	5/16 x 3	25	225-388	5/8 x 3	10
225-091	1/8 x 5/8	50	3/8			225-394	5/8 x 3-1/2	10
225-094	1/8 x 3/4	50	225-247	3/8 x 1/2	100	225-400	5/8 x 4	10
225-097	1/8 x 7/8	50	225-250	3/8 x 5/8	100	225-403	5/8 x 4-1/2	10
225-100	1/8 x 1	50	225-253	3/8 x 3/4	100	225-406	5/8 x 5	10
225-106	1/8 x 1-1/4	50	225-256	3/8 x 7/8	100	3/4		
225-112	1/8 x 1-1/2	50	225-259	3/8 x 1	100	225-412	3/4 x 2	10
225-115	1/8 x 1-3/4	50	225-262	3/8 x 1-1/4	100	225-418	3/4 x 2-1/2	10
225-118	1/8 x 2	50	225-268	3/8 x 1-1/2	100	225-424	3/4 x 3	10
3/16			225-271	3/8 x 1-3/4	100	225-430	3/4 x 3-1/2	10
225-121	3/16 x 1/2	50	225-274	3/8 x 2	100	225-436	3/4 x 4	10
225-124	3/16 x 5/8	50	225-277	3/8 x 2-1/4	100	225-439	3/4 x 4-1/2	10
225-127	3/16 x 3/4	50	225-280	3/8 x 2-1/2	100	225-442	3/4 x 5	10
225-130	3/16 x 7/8	50	225-286	3/8 x 3	100	225-445	3/4 x 6	10
225-133	3/16 x 1	50	7/16					
225-139	3/16 x 1-1/4	50	225-295	7/16 x 1	20			
225-145	3/16 x 1-1/2	50	225-298	7/16 x 1-1/4	20			
225-148	3/16 x 1-3/4	50	225-301	7/16 x 1-1/2	20			
225-151	3/16 x 2	50	225-304	7/16 x 1-3/4	20			

(*) PRODUITS SEMI STANDARD ET AUTRES DIMENSIONS NON LISTÉS - DISPONIBLE SUR DEMANDE

GOUPILLES CYLINDRIQUES DE PRÉCISION PRECISION GROUND DOWEL PINS

RENCONTRE / MEETS SPEC.: ANSI / ASME 18.8.2

ACIER / STEEL - STANDARD ALLOY



SPÉCIFICATION
Dureté
Core hardness : C47-58 / Rockwell
Case hardness : C60 min. / Rockwell
Shear strength : 130,000 PSI min.

NUMÉRO	DIMENSION			BTE	NUMÉRO	DIMENSION			BTE	BESOIN DE RANGEMENT? COMMUNIQUER AVEC NOUS AU 1-800-463-5259
7/8					1					
225-448	7/8	x	2	10	225-472	1	x	2	10	
225-451	7/8	x	2-1/2	10	225-475	1	x	2-1/2	10	
225-454	7/8	x	3	10	225-478	1	x	3	10	
225-457	7/8	x	3-1/2	10	225-481	1	x	3-1/2	10	
225-460	7/8	x	4	10	225-484	1	x	4	10	
225-463	7/8	x	4-1/2	10	225-487	1	x	4-1/2	5	
225-466	7/8	x	5	10	225-490	1	x	5	5	
225-469	7/8	x	6	10	225-493	1	x	6	5	

GOUPILLES CONIQUES TAPER PINS

MATERIEL : AISI-211 STEEL OU AISI-1212-1213

RENCONTRE / MEETS SPEC.: ASME B18.8.2 - 1994

ACIER / STEEL



NUMÉRO	DIMENSION			BTE	NUMÉRO	DIMENSION			BTE	NUMÉRO	DIMENSION			BTE
5/0					2/0 (suite)					2				
239-013	5/0	x	1/2	100	239-037	2/0	x	1-1/4	100	239-061	2	x	3/4	100
239-014	5/0	x	3/4	100	239-038	2/0	x	1-1/2	100	239-062	2	x	1	100
239-015	5/0	x	1	100	239-039	2/0	x	1-3/4	100	239-063	2	x	1-1/4	100
239-016	5/0	x	1-1/4	100	239-040	2/0	x	2	100	239-064	2	x	1-1/2	100
239-017	5/0	x	1-1/2	100	0				239-065	2	x	1-3/4	100	
4/0					239-043	0	x	1/2	100	239-066	2	x	2	100
239-020	4/0	x	1/2	100	239-044	0	x	3/4	100	239-067	2	x	2-1/4	100
239-021	4/0	x	3/4	100	239-045	0	x	1	100	239-068	2	x	2-1/2	100
239-022	4/0	x	1	100	239-046	0	x	1-1/4	100	239-069	2	x	2-3/4	100
239-023	4/0	x	1-1/4	100	239-047	0	x	1-1/2	100	239-070	2	x	3	100
239-024	4/0	x	1-1/2	100	239-048	0	x	1-3/4	100	239-071	2	x	3-1/2	100
3/0					239-049	0	x	2	100	3				
239-027	3/0	x	1/2	100	1				239-073	3	x	3/4	100	
239-028	3/0	x	3/4	100	239-052	1	x	3/4	100	239-074	3	x	1	100
239-029	3/0	x	1	100	239-053	1	x	1	100	239-075	3	x	1-1/4	100
239-030	3/0	x	1-1/4	100	239-054	1	x	1-1/4	100	239-076	3	x	1-1/2	100
239-031	3/0	x	1-1/2	100	239-055	1	x	1-1/2	100	239-077	3	x	1-3/4	100
2/0					239-056	1	x	1-3/4	100	239-078	3	x	2	100
239-034	2/0	x	1/2	100	239-057	1	x	2	100	239-079	3	x	2-1/4	100
239-035	2/0	x	3/4	100	239-058	1	x	2-1/4	100	239-080	3	x	2-1/2	100
239-036	2/0	x	1	100	239-059	1	x	2-1/2	100	239-081	3	x	2-3/4	100
					239-060	1	x	3	100	239-082	3	x	3	100
										239-083	3	x	3-1/2	100
										239-084	3	x	4	100

27-10-2023

GOUPILLES CONIQUES
TAPER PINS

MATERIEL : AISI-211 STEEL OU AISI-1212-1213
RENCONTRE / MEETS SPEC.: ASME B18.8.2 - 1994
ACIER / STEEL



NUMÉRO	DIMENSION	BTE	NUMÉRO	DIMENSION	BTE	NUMÉRO	DIMENSION	BTE																																																
4			6 (suite)			9																																																		
239-085	4 x 3/4	100	239-126	6 x 3-1/2	100	239-165	9 x 1-1/2	50																																																
239-086	4 x 1	100	239-127	6 x 3-3/4	100	239-166	9 x 2	50																																																
239-087	4 x 1-1/4	100	239-128	6 x 4	100	239-167	9 x 2-1/4	50																																																
239-088	4 x 1-1/2	100	239-129	6 x 4-1/2	100	239-168	9 x 2-1/2	50																																																
239-089	4 x 1-3/4	100	239-130	6 x 5	100	239-169	9 x 3	50																																																
239-090	4 x 2	100	239-131	6 x 5-1/2	100	239-170	9 x 3-1/2	50																																																
239-091	4 x 2-1/4	100	239-132	6 x 6	100	239-171	9 x 4	25																																																
239-092	4 x 2-1/2	100	7			239-172	9 x 4-1/2	25																																																
239-093	4 x 2-3/4	100	239-133	7 x 1-1/4	100	239-173	9 x 5	25																																																
239-094	4 x 3	100	239-134	7 x 1-1/2	100	239-174	9 x 5-1/2	25																																																
239-095	4 x 3-1/2	100	239-135	7 x 1-3/4	100	239-175	9 x 6	25																																																
239-096	4 x 4	100	239-136	7 x 2	100	10																																																		
5			239-137	7 x 2-1/4	100	239-176	10 x 1-1/2	25																																																
239-097	5 x 3/4	100	239-138	7 x 2-1/2	100	239-177	10 x 2	25																																																
239-099	5 x 1	100	239-139	7 x 2-3/4	100	239-178	10 x 2-1/2	25																																																
239-100	5 x 1-1/4	100	239-140	7 x 3	100	239-179	10 x 3	25																																																
239-101	5 x 1-1/2	100	239-141	7 x 3-1/4	100	239-180	10 x 3-1/4	25																																																
239-102	5 x 1-3/4	100	239-142	7 x 3-1/2	50	239-181	10 x 3-1/2	25																																																
239-103	5 x 2	100	239-143	7 x 3-3/4	50	239-182	10 x 4	25																																																
239-104	5 x 2-1/4	100	239-144	7 x 4	50	239-183	10 x 4-1/2	25																																																
239-105	5 x 2-1/2	100	239-145	7 x 4-1/2	50	239-184	10 x 5	25																																																
239-106	5 x 2-3/4	100	239-146	7 x 5	50	239-185	10 x 5-1/2	25																																																
239-107	5 x 3	100	239-147	7 x 5-1/2	50	239-186	10 x 6	25																																																
239-108	5 x 3-1/4	100	239-148	7 x 6	50	DIA. APPROXIMATIF DU BOUT LE PLUS LONG APPROXIMATE DIAMETER AT LARGE END <table border="1"> <thead> <tr> <th>DIMENSION</th> <th>DÉCIMAL</th> <th>FRACTION</th> </tr> </thead> <tbody> <tr><td>5/0</td><td>.094</td><td>3/32</td></tr> <tr><td>4/0</td><td>.109</td><td>7/64</td></tr> <tr><td>3/0</td><td>.125</td><td>1/8</td></tr> <tr><td>2/0</td><td>.141</td><td>9/64</td></tr> <tr><td>0</td><td>.156</td><td>5/32</td></tr> <tr><td>1</td><td>.172</td><td>11/64</td></tr> <tr><td>2</td><td>.193</td><td>3/16</td></tr> <tr><td>3</td><td>.213</td><td>7/32</td></tr> <tr><td>4</td><td>.250</td><td>1/4</td></tr> <tr><td>5</td><td>.289</td><td>19/64</td></tr> <tr><td>6</td><td>.341</td><td>11/32</td></tr> <tr><td>7</td><td>.409</td><td>13/32</td></tr> <tr><td>8</td><td>.492</td><td>1/2</td></tr> <tr><td>9</td><td>.591</td><td>19/32</td></tr> <tr><td>10</td><td>.706</td><td>23/32</td></tr> </tbody> </table>			DIMENSION	DÉCIMAL	FRACTION	5/0	.094	3/32	4/0	.109	7/64	3/0	.125	1/8	2/0	.141	9/64	0	.156	5/32	1	.172	11/64	2	.193	3/16	3	.213	7/32	4	.250	1/4	5	.289	19/64	6	.341	11/32	7	.409	13/32	8	.492	1/2	9	.591	19/32	10	.706	23/32
DIMENSION	DÉCIMAL	FRACTION																																																						
5/0	.094	3/32																																																						
4/0	.109	7/64																																																						
3/0	.125	1/8																																																						
2/0	.141	9/64																																																						
0	.156	5/32																																																						
1	.172	11/64																																																						
2	.193	3/16																																																						
3	.213	7/32																																																						
4	.250	1/4																																																						
5	.289	19/64																																																						
6	.341	11/32																																																						
7	.409	13/32																																																						
8	.492	1/2																																																						
9	.591	19/32																																																						
10	.706	23/32																																																						
239-109	5 x 3-1/2	100	8			239-149	8 x 1-1/4	50																																																
239-110	5 x 3-3/4	100	239-150	8 x 1-1/2	50	239-151	8 x 1-3/4	50																																																
239-111	5 x 4	100	239-151	8 x 1-3/4	50	239-152	8 x 2	50																																																
239-112	5 x 4-1/2	100	239-152	8 x 2	50	239-153	8 x 2-1/4	50																																																
239-113	5 x 5	100	239-153	8 x 2-1/4	50	239-154	8 x 2-1/2	50																																																
6			239-154	8 x 2-1/2	50	239-155	8 x 2-3/4	50																																																
239-115	6 x 3/4	100	239-155	8 x 2-3/4	50	239-156	8 x 3	50																																																
239-116	6 x 1	100	239-156	8 x 3	50	239-157	8 x 3-1/4	50																																																
239-117	6 x 1-1/4	100	239-157	8 x 3-1/4	50	239-158	8 x 3-1/2	50																																																
239-118	6 x 1-1/2	100	239-158	8 x 3-1/2	50	239-159	8 x 3-3/4	50																																																
239-119	6 x 1-3/4	100	239-159	8 x 3-3/4	50	239-160	8 x 4	50																																																
239-120	6 x 2	100	239-160	8 x 4	50	239-161	8 x 4-1/2	50																																																
239-121	6 x 2-1/4	100	239-161	8 x 4-1/2	50	239-162	8 x 5	50																																																
239-122	6 x 2-1/2	100	239-162	8 x 5	50	239-163	8 x 5-1/2	50																																																
239-123	6 x 2-3/4	100	239-163	8 x 5-1/2	50	239-164	8 x 6	50																																																
239-124	6 x 3	100	239-164	8 x 6	50																																																			
239-125	6 x 3-1/4	100																																																						

GOUPILLES À RESSORT
SPRING TENSIONS PINS

MATERIEL : SAE 1070-1095

RENCONTRE / MEETS SPEC.: ASME B18.8.2

ACIER / STEEL - CARBON

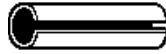

SPÉCIFICATION
Dureté / hardness:
1/16" Dia. : 458-560 / Vickers
5/64" à 3/32" Dia. : 15N 83.5-86.9 / Rockwell
1/8" à 1/4" Dia. : A73.6 - 77.4 / Rockwell
5/16" à 1/2" Dia. : C46 - 53 / Rockwell

NUMÉRO	DIMENSION	BTE	NUMÉRO	DIMENSION	BTE	NUMÉRO	DIMENSION	BTE
1/16 - .062			3/32 - .094 (suite)			5/32 - .156 (suite)		
192-101	1/16 x 3/16	50	192-569	3/32 x 1-1/8	50	192-590	5/32 x 1-7/8	50
192-550	1/16 x 1/4	50	192-121	3/32 x 1-1/4	50	192-591	5/32 x 2	50
192-102	1/16 x 5/16	50	192-570	3/32 x 1-3/8	50	192-592	5/32 x 2-1/4	50
192-102A	1/16 x 3/8	50	192-122	3/32 x 1-1/2	50	192-195	5/32 x 2-1/2	50
192-551	1/16 x 7/16	50	1/8 - .125			3/16 - .187		
192-103	1/16 x 1/2	50	192-181	1/8 x 1/4	50	192-593	3/16 x 3/8	50
192-104	1/16 x 5/8	50	192-123	1/8 x 3/8	50	192-139	3/16 x 1/2	50
192-105	1/16 x 3/4	50	192-571	1/8 x 7/16	50	192-594	3/16 x 9/16	50
192-106	1/16 x 7/8	50	192-124	1/8 x 1/2	50	192-140	3/16 x 5/8	50
192-107	1/16 x 1	50	192-572	1/8 x 9/16	50	192-595	3/16 x 11/16	50
5/64 - .078			192-125	1/8 x 5/8	50	192-141	3/16 x 3/4	50
192-552	5/64 x 3/16	50	192-573	1/8 x 11/16	50	192-596	3/16 x 13/16	50
192-108	5/64 x 1/4	50	192-126	1/8 x 3/4	50	192-597	3/16 x 7/8	50
192-553	5/64 x 5/16	50	192-574	1/8 x 13/16	50	192-598	3/16 x 15/16	50
192-554	5/64 x 3/8	50	192-127	1/8 x 7/8	50	192-142	3/16 x 1	50
192-555	5/64 x 7/16	50	192-575	1/8 x 15/16	50	192-599	3/16 x 1-1/8	50
192-109	5/64 x 1/2	50	192-128	1/8 x 1	50	192-143	3/16 x 1-1/4	50
192-110	5/64 x 9/16	50	192-576	1/8 x 1-1/8	50	192-600	3/16 x 1-3/8	50
192-556	5/64 x 5/8	50	192-129	1/8 x 1-1/4	50	192-144	3/16 x 1-1/2	50
192-557	5/64 x 11/16	50	192-577	1/8 x 1-3/8	50	192-601	3/16 x 1-5/8	50
192-111	5/64 x 3/4	50	192-130	1/8 x 1-1/2	50	192-145	3/16 x 1-3/4	100
192-558	5/64 x 13/16	50	192-578	1/8 x 1-5/8	50	192-602	3/16 x 1-7/8	50
192-559	5/64 x 7/8	50	192-131	1/8 x 1-3/4	100	192-146	3/16 x 2	50
192-560	5/64 x 15/16	50	192-579	1/8 x 1-7/8	100	192-603	3/16 x 2-1/4	50
192-112	5/64 x 1	50	192-132	1/8 x 2	100	192-604	3/16 x 2-1/2	50
192-561	5/64 x 1-1/8	50	5/32 - .156			7/32 - .219		
192-113	5/64 x 1-1/4	50	192-133A	5/32 x 3/8	50	192-605	7/32 x 9/16	50
192-562	5/64 x 1-3/8	50	192-580	5/32 x 7/16	50	192-147	7/32 x 5/8	50
192-114	5/64 x 1-1/2	50	192-133	5/32 x 1/2	50	192-606	7/32 x 11/16	50
3/32 - .094			192-581	5/32 x 9/16	50	192-182	7/32 x 3/4	50
192-563	3/32 x 1/4	50	192-134	5/32 x 5/8	50	192-607	7/32 x 13/16	50
192-115	3/32 x 5/16	50	192-582	5/32 x 11/16	50	192-608	7/32 x 7/8	50
192-115A	3/32 x 3/8	50	192-135	5/32 x 3/4	50	192-609	7/32 x 15/16	50
192-564	3/32 x 7/16	50	192-583	5/32 x 13/16	50	192-183	7/32 x 1	50
192-116	3/32 x 1/2	50	192-584	5/32 x 7/8	50	192-610	7/32 x 1-1/8	50
192-565	3/32 x 9/16	50	192-585	5/32 x 15/16	50	192-187	7/32 x 1-1/4	50
192-117	3/32 x 5/8	50	192-136	5/32 x 1	50	192-148	7/32 x 1-3/8	50
192-566	3/32 x 11/16	50	192-586	5/32 x 1-1/8	50	192-194	7/32 x 1-1/2	50
192-118	3/32 x 3/4	50	192-137	5/32 x 1-1/4	50	192-611	7/32 x 1-5/8	50
192-567	3/32 x 13/16	50	192-587	5/32 x 1-3/8	50	192-149	7/32 x 1-3/4	50
192-119	3/32 x 7/8	50	192-138	5/32 x 1-1/2	50	192-612	7/32 x 1-7/8	50
192-568	3/32 x 15/16	50	192-588	5/32 x 1-5/8	50	192-188	7/32 x 2	50
192-120	3/32 x 1	50	192-589	5/32 x 1-3/4	50	192-613	7/32 x 2-1/4	50

27-10-2023

GOUPILLES À RESSORT
SPRING TENSIONS PINS

MATERIEL : SAE 1070-1095
RENCONTRE / MEETS SPEC.: ASME B18.8.2
ACIER / STEEL - CARBON

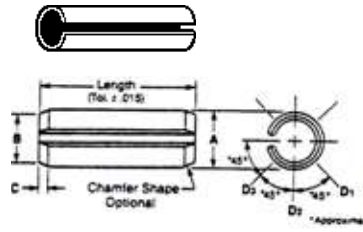

SPÉCIFICATION	
Dureté	
1/16" Dia. :	458-560 / Vickers
5/64" à 3/32" Dia. :	15N 83.5-86.9 / Rockwell
1/8" à 1/4" Dia. :	A73.6 - 77.4 / Rockwell
5/16" à 1/2" Dia. :	C46 - 53 / Rockwell

NUMÉRO	DIMENSION	BTE	NUMÉRO	DIMENSION	BTE	NUMÉRO	DIMENSION	BTE
7/32 - .219 (suite)			5/16 - .312 (suite)			7/16 - .437 (suite)		
192-614	7/32 x 2-1/2	50	192-636	5/16 x 3	25	192-649	7/16 x 1-1/2	25
192-615	7/32 x 2-3/4	50	192-637	5/16 x 3-1/4	25	192-650	7/16 x 1-3/4	25
192-616	7/32 x 3		192-638	5/16 x 3-1/2	25	192-651	7/16 x 2	25
50			192-639	5/16 x 3-3/4	25	192-652	7/16 x 2-1/4	25
1/4 - .250			192-640			192-653		
192-617	1/4 x 1/2	50				7/16 - .437 (suite)		
192-150	1/4 x 5/8	50	3/8 - .375			192-654	7/16 x 2-3/4	25
192-618	1/4 x 11/16	50	192-167	3/8 x 3/4	25	192-655	7/16 x 3	50
192-151	1/4 x 3/4	50	192-168	3/8 x 1	25	192-656	7/16 x 3-1/4	25
192-619	1/4 x 13/16	50	192-641	3/8 x 1-1/4	25	192-657	7/16 x 3-1/2	25
192-152	1/4 x 7/8	50	192-169	3/8 x 1-1/2	25	192-658	7/16 x 3-3/4	25
192-620	1/4 x 15/16	50	192-172	3/8 x 1-3/4	25	192-659	7/16 x 4	25
192-153	1/4 x 1	50	192-170	3/8 x 2	25	1/2 - 500		
192-621	1/4 x 1-1/8	50	192-642	3/8 x 2-1/4	25	192-660	1/2 x 1-1/4	25
192-154	1/4 x 1-1/4	50	192-171	3/8 x 2-1/2	25	192-661	1/2 x 1-1/2	25
192-622	1/4 x 1-3/8	50	192-643	3/8 x 2-3/4	25	192-197	1/2 x 1-3/4	25
192-155	1/4 x 1-1/2	50	192-175	3/8 x 3	25	192-185	1/2 x 2	25
192-623	1/4 x 1-5/8	50	192-644	3/8 x 3-1/4	25	192-662	1/2 x 2-1/4	25
192-156	1/4 x 1-3/4	50	192-645	3/8 x 3-1/2	25	192-184	1/2 x 2-1/2	25
192-624	1/4 x 1-7/8	50	192-646	3/8 x 3-3/4	25	192-663	1/2 x 2-3/4	25
192-157	1/4 x 2	100	192-180	3/8 x 4	25	192-664	1/2 x 3	25
192-158	1/4 x 2-1/4	100	7/16 - .437			192-665	1/2 x 3-1/4	25
192-159	1/4 x 2-1/2	50	192-647	7/16 x 1	25	192-666	1/2 x 3-1/2	25
192-625	1/4 x 2-3/4	25	192-648	7/16 x 1-1/4	25	192-667	1/2 x 3-3/4	25
192-190	1/4 x 3	25				192-186	1/2 x 4	25
192-626	1/4 x 3-1/4	25						
192-627	1/4 x 3-1/2	25						

SPÉCIFICATIONS SUR LES DIMENSIONS DE GOUPILLES À RESSORT

DIMENSIONS OF SPRING-TENSION PINS / SPECIFICATIONS

VOIR SHÉMA CI-HAUT

Pin. Dia. Nominal	Max. Dia. Go Ring Gage	D1+D2+D3 3	Max.	Nom.	Wall Thickness	Recommended Hole size		Min. Double Shear Strength in Pounds
						Min.	Max.	
1/16 (.062)	.069	.066	.059	.011	.012	.062	.065	430
5/64 (.078)	.086	.083	.075	.014	.018	.078	.081	800
3/32 (.094)	.103	.099	.091	.018	.022	.094	.097	1150
1/4 (.125)	.135	.131	.122	.024	.028	.125	.129	1875
5/32 (.156)	.167	.162	.151	.028	.032	.156	.160	2750
3/16 (.187)	.199	.194	.182	.036	.040	.187	.192	4150
7/32 (.219)	.232	.226	.214	.042	.048	.219	.224	5850
1/4 (.250)	.264	.258	.245	.042	.050	.250	.256	7050
5/16 (.312)	.330	.321	.306	.060	.062	.312	.318	10,800
3/8 (.375)	.395	.385	.368	.060	.077	.375	.382	16,300
7/16 (.437)	.459	.448	.430	.060	.077	.437	.445	19,800
1/2 (.500)	.524	.513	.485	.060	.094	.500	.510	27,100

**GOUPILLES À RESSORT EN SPIRALE
COILED SPRING PINS**

RENCONTRE / MEETS SPEC.: ANSI 1070 TO 1095 STEEL

**ACIER CARBONE / STEEL CARBON (1070-1095)
FINI NOIR / PLAIN FINISH**



"D" = EXPANDED DIAMETER, "H" = HOLE SIZE, "W" = WALL THICKNESS

HARDNESS SPÉCIFICATIONS					
Stock	Over	-	0.010"	0.025"	0.050"
Dureté / thickness					
Range	Thru	0.010"	0.025"	0.050"	-
Hardness Test		Tukon Knoop	Rockwell 15N	Rockwell A	Rockwell C
Material		Hardness Reading			
AISI 1070 To 1095 Steel		480 to 594	83.5 to 86.9	73.6 to 77.4	46 to 53

NUMÉRO	DIMENSION	BTE	NUMÉRO	DIMENSION	BTE	NUMÉRO	DIMENSION	BTE
1/16 - D : .072-.067 - H : .065-.061 - W : .005			3/32 - D : .105-.099 - H : .097-.093 - W : .007			1/8 - D : .138-.131 - H : .129-.124 - W : .010		
192-515	1/16 x 3/16	100	192-241	3/32 x 7/8	100	192-273	1/8 x 1-1/8	100
192-516	1/16 x 1/4	100	192-242	3/32 x 15/16	100	192-274	1/8 x 1-1/4	100
192-201	1/16 x 5/16	100	192-243	3/32 x 1	100	192-275	1/8 x 1-3/8	100
192-202	1/16 x 3/8	100	192-244	3/32 x 1-1/8	100	192-276	1/8 x 1-1/2	100
192-203	1/16 x 7/16	100	192-245	3/32 x 1-1/4	100	192-277	1/8 x 1-5/8	100
192-204	1/16 x 1/2	100	192-246	3/32 x 1-3/8	100	192-278	1/8 x 1-3/4	100
192-205	1/16 x 9/16	100	192-247	3/32 x 1-1/2	100	192-279	1/8 x 1-7/8	100
192-206	1/16 x 5/8	100	192-248	3/32 x 1-5/8	100	192-280	1/8 x 2	100
192-207	1/16 x 11/16	100	192-249	3/32 x 1-3/4	100	5/32 - D : .171-.163 - H : .160-.155 - W : .012		
192-208	1/16 x 3/4	100	7/64 - D : .120-.114 - H : .112-.108 - W : .008			192-281	5/32 x 5/16	100
192-209	1/16 x 13/16	100	192-495	7/64 x 1/4	100	192-282	5/32 x 3/8	100
192-210	1/16 x 7/8	100	192-496	7/64 x 5/16	100	192-283	5/32 x 7/16	100
192-211	1/16 x 15/16	100	192-497	7/64 x 3/8	100	192-284	5/32 x 1/2	100
192-212	1/16 x 1	100	192-498	7/64 x 7/16	100	192-285	5/32 x 9/16	100
5/64 - D : .088-.083 - H : .081-.077 - W : .006			192-499	7/64 x 1/2	100	192-286	5/32 x 5/8	100
192-215	5/64 x 3/16	100	192-500	7/64 x 9/16	100	192-287	5/32 x 11/16	100
192-216	5/64 x 1/4	100	192-501	7/64 x 5/8	100	192-288	5/32 x 3/4	100
192-217	5/64 x 5/16	100	192-502	7/64 x 3/4	100	192-289	5/32 x 13/16	100
192-218	5/64 x 3/8	100	192-503	7/64 x 13/16	100	192-290	5/32 x 7/8	100
192-219	5/64 x 7/16	100	192-504	7/64 x 15/16	100	192-291	5/32 x 15/16	100
192-220	5/64 x 1/2	100	192-505	7/64 x 1	100	192-416	5/32 x 1	100
192-221	5/64 x 9/16	100	192-506	7/64 x 1-1/8	100	192-273	5/32 x 1-1/8	100
192-222	5/64 x 5/8	100	192-507	7/64 x 1-1/4	100	192-294	5/32 x 1-1/4	100
192-223	5/64 x 11/16	100	192-508	7/64 x 1-3/8	100	192-295	5/32 x 1-3/8	100
192-224	5/64 x 3/4	100	192-509	7/64 x 1-1/2	100	192-418	5/32 x 1-1/2	100
192-225	5/64 x 13/16	100	192-510	7/64 x 1-5/8	100	192-297	5/32 x 1-5/8	100
192-226	5/64 x 7/8	100	192-511	7/64 x 1-3/4	100	192-298	5/32 x 1-3/4	100
192-227	5/64 x 15/16	100	192-512	7/64 x 1-7/8	100	192-299	5/32 x 1-7/8	100
192-228	5/64 x 1	100	192-513	7/64 x 2	100	192-300	5/32 x 2	100
192-229	5/64 x 1-1/8	100	1/8 - D : .138-.131 - H : .129-.124 - W : .010			192-301	5/32 x 2-1/4	100
192-230	5/64 x 1-1/4	100	192-260	1/8 x 1/4	100	192-302	5/32 x 2-1/2	100
3/32 - D : .105-.099 - H : .097-.093 - W : .007			192-261	1/8 x 5/16	100	3/16 - D : .205-.196 - H : .192-.185 - W : .016		
192-517	3/32 x 3/16	100	192-262	1/8 x 3/8	100	192-303	3/16 x 3/8	100
192-231	3/32 x 1/4	100	192-263	1/8 x 7/16	100	192-304	3/16 x 7/16	100
192-232	3/32 x 5/16	100	192-264	1/8 x 1/2	100	192-305	3/16 x 1/2	100
192-233	3/32 x 3/8	100	192-265	1/8 x 9/16	100	192-306	3/16 x 9/16	100
192-234	3/32 x 7/16	100	192-266	1/8 x 5/8	100	192-307	3/16 x 5/8	100
192-235	3/32 x 1/2	100	192-267	1/8 x 11/16	100	192-308	3/16 x 11/16	100
192-236	3/32 x 9/16	100	192-268	1/8 x 3/4	100	192-309	3/16 x 3/4	100
192-237	3/32 x 5/8	100	192-269	1/8 x 13/16	100	192-310	3/16 x 13/16	100
192-238	3/32 x 11/16	100	192-270	1/8 x 7/8	100	192-311	3/16 x 7/8	100
192-239	3/32 x 3/4	100	192-271	1/8 x 15/16	100	192-312	3/16 x 15/16	100
192-240	3/32 x 13/16	100	192-272	1/8 x 1	100	192-313	3/16 x 1	100

27-10-2023

**GOUPILLES À RESSORT EN SPIRALE
COILED SPRING PINS**

RENCONTRE / MEETS SPEC.: ANSI 1070 TO 1095 STEEL

ACIER CARBONE / STEEL CARBON (1070-1095)

FINI NOIR / PLAIN FINISH



"D" = EXPANDED DIAMETER, "H" = HOLE SIZE, "W" = WALL THICKNESS

HARDNESS SPÉCIFICATIONS					
Stock	Over	-	0.010"	0.025"	0.050"
Dureté / thickness	Thru	0.010"	0.025"	0.050"	-
Range					
Hardness Test	Tukon Knoop	Rockwell 15N	Rockwell A	Rockwell C	
Material		Hardness Reading			
AISI 1070 To 1095 Steel	480 to 594	83.5 to 86.9	73.6 to 77.4	46	53

NUMÉRO	DIMENSION	BTE	NUMÉRO	DIMENSION	BTE	NUMÉRO	DIMENSION	BTE
3/16 - D : .205-.196 - H : .192-.185 - W : .016			1/4 - D : .271-.260 - H : .256-.247 - W : .021			3/8 - D : .403-.388 - H : .383-.370 - W : .032		
192-314	3/16 x 1-1/8	100	192-377	1/4 x 1-1/2	100	192-454	3/8 x 2-1/2	25
192-315	3/16 x 1-1/4	100	192-378	1/4 x 1-5/8	100	192-455	3/8 x 2-3/4	25
192-316	3/16 x 1-3/8	100	192-379	1/4 x 1-3/4	100	192-456	3/8 x 3	25
192-317	3/16 x 1-1/2	100	192-380	1/4 x 1-7/8	50	192-457	3/8 x 3-1/4	25
192-318	3/16 x 1-5/8	100	192-381	1/4 x 2	100	192-458	3/8 x 3-1/2	25
192-319	3/16 x 1-3/4	100	192-382	1/4 x 2-1/4	100	192-459	3/8 x 3-3/4	25
192-320	3/16 x 1-7/8	100	192-383	1/4 x 2-1/2	100	192-460	3/8 x 4	25
192-321	3/16 x 2	100	192-384	1/4 x 2-3/4	100	192-461	3/8 x 4-1/2	25
192-322	3/16 x 2-1/4	100	192-385	1/4 x 3	100	7/16 - D : .469-.452 - H : .446-.431 - W : .038		
192-323	3/16 x 2-1/2	100	192-386	1/4 x 3-1/4	100	192-462	7/16 x 1	25
7/32 - D : .238-.228 - H : .224-.217 - W : .018			192-387	1/4 x 3-1/2	100	192-463	7/16 x 1-1/4	25
192-340	7/32 x 1/2	100	5/16 - D : .337-.324 - H : .319-.308 - W : .025			192-464	7/16 x 1-1/2	25
192-341	7/32 x 9/16	100	5/16 x 5/8	50	192-465	7/16 x 1-3/4	25	
192-342	7/32 x 5/8	100	192-391	5/16 x 11/16	50	192-466	7/16 x 2	25
192-343	7/32 x 11/16	100	192-392	5/16 x 3/4	50	192-467	7/16 x 2-1/4	25
192-344	7/32 x 3/4	100	192-393	5/16 x 13/16	50	192-468	7/16 x 2-1/2	25
192-345	7/32 x 13/16	100	192-394	5/16 x 7/8	50	192-469	7/16 x 2-3/4	25
192-346	7/32 x 7/8	100	192-395	5/16 x 15/16	50	192-470	7/16 x 3	25
192-347	7/32 x 15/16	100	192-396	5/16 x 1	50	192-471	7/16 x 3-1/4	25
192-348	7/32 x 1	100	192-397	5/16 x 1-1/8	50	192-472	7/16 x 3-1/2	25
192-349	7/32 x 1-1/8	100	192-398	5/16 x 1-1/4	50	192-473	7/16 x 3-3/4	25
192-422	7/32 x 1-1/4	100	192-399	5/16 x 1-3/8	50	192-474	7/16 x 4	25
192-351	7/32 x 1-3/8	100	192-400	5/16 x 1-1/2	50	192-475	7/16 x 4-1/4	25
192-424	7/32 x 1-1/2	100	192-401	5/16 x 1-5/8	50	192-476	7/16 x 4-1/2	25
192-353	7/32 x 1-5/8	100	192-402	5/16 x 1-3/4	50	1/2 - D : .535-.516 - H : .510-.493 - W : .042		
192-354	7/32 x 1-3/4	100	192-403	5/16 x 1-7/8	50	192-477	1/2 x 1-1/4	25
192-355	7/32 x 1-7/8	100	192-404	5/16 x 2	50	192-478	1/2 x 1-1/2	25
192-356	7/32 x 2	100	192-405	5/16 x 2-1/4	50	192-479	1/2 x 1-3/4	25
192-357	7/32 x 2-1/4	100	192-406	5/16 x 2-1/2	50	192-480	1/2 x 2	25
192-358	7/32 x 2-1/2	100	192-407	5/16 x 2-3/4	50	192-481	1/2 x 2-1/4	25
1/4 - D : .271-.260 - H : .256-.247 - W : .021			192-408	5/16 x 3	50	192-482	1/2 x 2-1/2	25
192-365	1/4 x 1/2	100	192-409	5/16 x 3-1/4	50	192-483	1/2 x 2-3/4	25
192-366	1/4 x 9/16	100	192-410	5/16 x 3-1/2	50	192-484	1/2 x 3	25
192-367	1/4 x 5/8	100	192-411	5/16 x 3-3/4	50	192-485	1/2 x 3-1/4	25
192-368	1/4 x 11/16	100	192-412	5/16 x 4	50	192-486	1/2 x 3-1/2	25
192-369	1/4 x 3/4	100	3/8 - D : .403-.388 - H : .383-.370 - W : .032			192-487	1/2 x 3-3/4	25
192-370	1/4 x 13/16	100	192-450	3/8 x 3/4	25	192-488	1/2 x 4	25
192-371	1/4 x 7/8	100	192-451	3/8 x 1	25	192-489	1/2 x 4-1/2	25
192-372	1/4 x 15/16	100	192-452	3/8 x 1-1/4	25	192-490	1/2 x 4-3/4	25
192-373	1/4 x 1	100	192-436	3/8 x 1-1/2	25	192-491	1/2 x 5	25
192-374	1/4 x 1-1/8	100	192-438	3/8 x 1-3/4	25	*		
192-375	1/4 x 1-1/4	100	192-440	3/8 x 2	25	*Autres dimensions disponibles sur demande.		
192-376	1/4 x 1-3/8	100	192-453	3/8 x 2-1/4	25			

CLAVETTES "WOODRUFF"
WOODRUFF KEYS

ACIER / STEEL

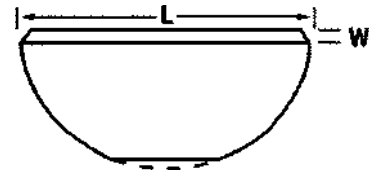
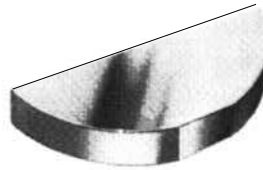

NUMÉRO	DIMENSION (W) LARGE x LONG (L)		BTE
1/16			
198-750	1/16	x 1/4	25
198-752	1/16	x 3/8	25
P302-010	1/16	x 1/2	25
1/8			
198-754	1/8	x 3/8	25
198-101	1/8	x 1/2	25
198-102	1/8	x 5/8	25
198-103	1/8	x 3/4	25
3/32			
198-751	3/32	x 5/16	25
198-753	3/32	x 3/8	25
P302-020	3/32	x 1/2	25
198-104	3/32	x 5/8	25
5/32			
198-105	5/32	x 5/8	25
198-106	5/32	x 3/4	25
198-107	5/32	x 7/8	25
3/16			
P302-061	3/16	x 5/8	25
198-108	3/16	x 3/4	25
198-109	3/16	x 7/8	25
198-110	3/16	x 1	25
198-757	3/16	x 1-1/8	25
P302-190	3/16	x 1-1/4	25
198-111	3/16	x 1-1/2	25
198-759 (2)	3/16	x 2-1/8	25
198-762 (1)	3/16	x 2-1/8	25
7/32			
198-112	7/32	x 7/8	25
198-113	7/32	x 1	25
198-114	7/32	x 1-1/8	25
P302-200	7/32	x 1-1/4	25
1/4			
P302-091	1/4	x 3/4	25
198-115	1/4	x 7/8	25
198-116	1/4	x 1	25
198-117	1/4	x 1-1/8	25
198-118	1/4	x 1-1/4	25
P302-220	1/4	x 1-3/8	25
P302-240	1/4	x 1-1/2	25
P302-270	1/4	x 2-1/8	25
198-760 (2)	1/4	x 2-1/8	25
5/16			
198-119	5/16	x 1	25
198-120	5/16	x 1-1/8	25
P302-214	5/16	x 1-1/4	25
198-758	5/16	x 1-3/8	25
P302-250	5/16	x 1-1/2	25
P302-280	5/16	x 2-1/8	25
198-761 (2)	5/16	x 2-1/8	25
P302-292	5/16	x 2-3/4	25
198-764 (2)	5/16	x 2-3/4	25
3/8			
198-756	3/8	x 1	25
P302-215	3/8	x 1-1/4	25
P302-236	3/8	x 1-3/8	25
P302-257	3/8	x 1-1/2	25
P302-290	3/8	x 2-1/8	25
198-763 (1)	3/8	x 2-1/8	25
P302-291	3/8	x 2-3/4	25
1/2			
198-765	1/2	x 2-3/4	25

BARRES À CLAVETTES / CARRÉE
MACHINE KEY STOCK / SQUARE

PLAQUÉ ZINC / ZINC PLATED

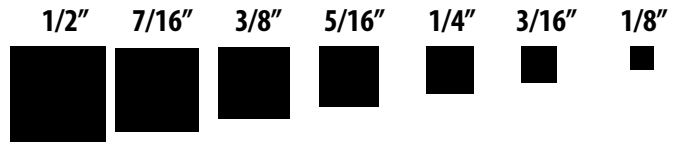

LONGUEUR		DIMENSION	
12 POUCES	36 POUCES	CARRÉE	
198-300	198-400	1/16	x 1/16
198-302	198-402	3/32	x 3/32
198-130	198-430	1/8	x 1/8
198-303	-	5/32	x 5/32
198-131	198-431	3/16	x 3/16
198-304	198-403	7/32	x 7/32
198-132	198-432	1/4	x 1/4
198-305	198-405	9/32	x 9/32
198-133	198-433	5/16	x 5/16
198-134	198-434	3/8	x 3/8
198-135	198-435	7/16	x 7/16
198-136	198-436	1/2	x 1/2
198-137	198-437	9/16	x 9/16
198-138	198-438	5/8	x 5/8

LONGUEUR		DIMENSION	
12 POUCES	36 POUCES	CARRÉE	
198-139	198-439	3/4	x 3/4
198-306	198-406	11/16	x 11/16
198-307	198-407	13/16	x 13/16
198-140	198-440	7/8	x 7/8
198-393	198-404	15/16	x 15/16
198-141	198-441	1	x 1
	198-411	1-1/16	x 1-1/16
198-144	198-444	1-1/8	x 1-1/8
198-146	198-446	1-3/16	x 1-3/16
198-148	198-408	1-1/4	x 1-1/4
198-308	198-409	1-3/8	x 1-3/8
198-412	198-452	1-1/2	x 1-1/2
198-309	-	1-5/8	x 1-5/8
198-311	198-410	1-3/4	x 1-3/4
198-312	-	1-7/8	x 1-7/8

BARRES À CLAVETTES / CARRÉE
MACHINE KEY STOCK / SQUARE

ACIER INOXYDABLE / STAINLESS STEEL

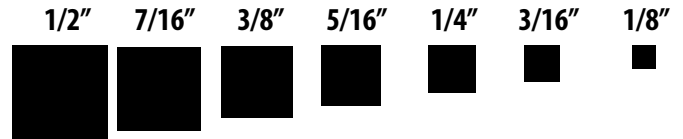

LONGUEUR		DIMENSION	
12 POUCES	36 POUCES	CARRÉE	
198-130AI	-	1/8	x 1/8
198-131AI	-	3/16	x 3/16
198-132AI	-	1/4	x 1/4
198-134AI	-	3/8	x 3/8
198-135AI	-	7/16	x 7/16
198-136AI	-	1/2	x 1/2

LONGUEUR		DIMENSION	
12 POUCES	36 POUCES	CARRÉE	
198-137AI	-	9/16	x 9/16
198-138AI	-	5/8	x 5/8
198-139AI	-	3/4	x 3/4
198-140AI	-	7/8	x 7/8
198-141AI	-	1	x 1

BARRES À CLAVETTES / RECTANGULAIRE
MACHINE KEY STOCK / RECTANGULAR



ACIER / STEEL

LONGUEUR		DIMENSION		LONGUEUR		DIMENSION	
12 POUCES	36 POUCES	RECTANGULAIRE		12 POUCES	36 POUCES	RECTANGULAIRE	
1/8				1/2			
198-201	198-316	1/8	x 3/16	198-333	-	1/2	x 11/16
198-205	-	1/8	x 1/4	198-335	198-372	1/2	x 7/8
198-210	-	1/8	x 3/8	198-336	198-376	1/2	x 1
198-394	-	1/8	x 1/2	198-337	198-398	1/2	x 1-1/8
198-212	-	1/8	x 5/8	198-338	198-399	1/2	x 2
198-214	-	1/8	x 3/4	9/16			
3/16				198-340	-	9/16	x 5/8
198-216	198-317	3/16	x 1/4	198-142	-	9/16	x 3/4
198-235	-	3/16	x 5/16	198-341	-	9/16	x 1
198-240	198-318	3/16	x 3/8	5/8			
198-245	-	3/16	x 1/2	198-342	-	5/8	x 11/16
198-247	-	3/16	x 5/8	198-323	-	5/8	x 3/4
198-249	-	3/16	x 7/8	198-343	198-377	5/8	x 7/8
1/4				198-344	198-378	5/8	x 1
198-256	-	1/4	x 5/16	198-345	198-380	5/8	x 1-1/4
198-259	198-319	1/4	x 3/8	3/4			
198-263	198-321	1/4	x 7/16	198-346	198-381	3/4	x 7/8
198-265	198-396	1/4	x 1/2	198-442	198-382	3/4	x 1
198-268	-	1/4	x 5/8	198-347	198-383	3/4	x 1-1/8
198-270	-	1/4	x 3/4	198-348	198-384	3/4	x 1-1/4
5/16				198-349	198-385	3/4	x 1-1/2
198-395	198-397	5/16	x 3/8	7/8			
198-282	198-325	5/16	x 7/16	198-350	198-386	7/8	x 1
198-280	198-326	5/16	x 1/2	198-351	-	7/8	x 1-1/8
198-284	-	5/16	x 9/16	198-352	198-387	7/8	x 1-1/4
198-290	-	5/16	x 5/8	1			
198-292	-	5/16	x 3/4	198-353	-	1	x 1-1/8
3/8				198-354	198-388	1	x 1-1/4
198-315	-	3/8	x 7/16	198-355	198-389	1	x 1-1/2
198-296	198-364	3/8	x 1/2	198-356	-	1	x 1-3/4
198-327	-	3/8	x 9/16	198-390	-	1	x 2
198-297	-	3/8	x 5/8	1-1/8			
198-310	198-366	3/8	x 3/4	198-357	-	1-1/8	x 1-1/4
198-328	-	3/8	x 1	1-1/4			
7/16				198-358	-	1-1/4	x 1-3/8
198-320	198-368	7/16	x 1/2	198-359	-	1-1/4	x 1-1/2
198-329	-	7/16	x 9/16	198-360	-	1-1/4	x 1-3/4
198-330	-	7/16	x 5/8	1-1/2			
198-331	-	7/16	x 3/4	198-361	198-391	1-1/2	x 1-3/4
1/2				198-362	198-392	1-1/2	x 2
198-332	198-369	1/2	x 9/16	1-1/2			
198-322	198-371	1/2	x 5/8	1-1/2			
198-334	198-401	1/2	x 3/4	1-1/2			

27-10-2023

ACIER EN RONDIN DE PRÉCISION
DRILL ROD ROUNDS

W-1 DURCI À L'EAU / WATER HARDENED

ACIER CARBON / CARBON STEEL
36" LONG

Fourni dans l'état adouci, avec une finition de surface polie et meulée.
Son exactitude dimensionnelle, ses propriétés uniformes sans défauts ni décarburation, lui ouvrent un éventail très large d'applications.

DIMENSION	NUMÉRO	BTE	DIMENSION	NUMÉRO	BTE	DIMENSION	NUMÉRO	BTE
1/16	DRD1160	10	27/64	DRD2764	1	51/64	DRD5164	1
5/64	DRD5640	10	7/16	DRD7160	1	13/16	DRD1316	1
3/32	DRD3320	10	29/64	DRD2964	1	53/64	DRD5364	1
7/64	DRD7640	10	15/32	DRD1532	1	27/32	DRD2732	1
1/8	DRD1800	10	31/64	DRD3164	1	7/8	DRD7800	1
9/64	DRD9640	10	1/2	DRD1200	1	57/64	DRD5764	1
5/32	DRD5320	10	33/64	DRD3364	1	29/32	DRD2932	1
11/64	DRD1164	10	17/32	DRD1732	1	15/16	DRD1516	1
3/16	DRD1161	10	35/64	DRD3564	1	31/32	DRD3132	1
13/64	DRD1364	6	9/16	DRD9160	1	63/64	DRD6364	1
7/32	DRD7320	6	7/64	DRD3764	1	1	DRD1000	1
15/64	DRD1564	6	19/32	DRD1932	1	1-1/16	DRD11160	1
1/4	DRD1400	6	39/64	DRD3964	1	1-1/8	DRD11800	1
17/64	DRD1764	6	5/8	DRD5800	1	1-3/16	DRD13160	1
9/32	DRD9320	6	41/64	DRD4164	1	1-1/4	DRD11400	1
19/64	DRD1964	4	21/32	DRD2132	1	1-5/16	DRD5160	1
5/16	DRD5160	4	43/64	DRD4364	1	1-3/8	DRD13800	1
21/64	DRD2164	4	11/16	DRD1116	1	1-7/16	DRD7160	1
11/32	DRD1132	4	23/32	DRD2332	1	1-1/2	DRD11200	1
23/64	DRD2364	4	47/64	DRD4764	1	1-5/8	DRD15800	1
3/8	DRD3800	4	3/4	DRD3400	1	1-3/4	DRD13400	1
25/64	DRD2564	1	49/64	DRD4964	1	2	DRD2000	1
13/32	DRD1332	1	25/32	DRD2532	1			

ACIER EN RONDIN DE PRÉCISION - MÉTRIQUE
DRILL ROD ROUNDS - METRIC

O-1 DURCI À L'HUILE / OIL HARDENED

ACIER CARBON / CARBON STEEL
1 METRE LONG

DIMENSION	NUMÉRO	BTE	DIMENSION	NUMÉRO	BTE	DIMENSION	NUMÉRO	BTE
2mm	DRD2	10	9mm	DRD9	6	18mm	DRD18	1
3mm	DRD3	10	10mm	DRD10	1	20mm	DRD20	1
4mm	DRD4	10	11mm	DRD11	1	22mm	DRD22	1
5mm	DRD5	10	12mm	DRD12	1	25mm	DRD25	1
6mm	DRD6	10	13mm	DRD13	1	30mm	DRD30	1
7mm	DRD7	6	14mm	DRD14	1			
8mm	DRD8	6	15mm	DRD15	1			
			16mm	DRD16	1			

27-10-2023

BARES A CLAVETTE A PALLIER STEP KEYSTOCK

ACIER 1018 / STEEL 1018

LONGUEUR DE 12 POUÇES / 12 INCH LENGTHS

UTILISATION : ACCOUPLEMENT, ENGRENAGE, POULIE, ENGRENAGE. UTILE POUR TOUT PLACE OU IL FAUT BARÉ SUR UN SHAFT. /
USE FOR COUPLINGS, GEARS, SHEAVES, SPROCKETS, PULLEYS - ANYTHING THAT KEYS TO A SHAFT.

TOLERANCE :

TYPE 1

A & C DIMENSIONS: -.000/+ .002

B & D DIMENSIONS : -.004/+ .004

TYPE 2

C & A DIMENSIONS: -.000/+ .002

B & D DIMENSIONS : -.005/+ .005

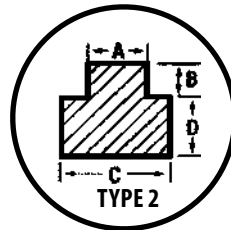
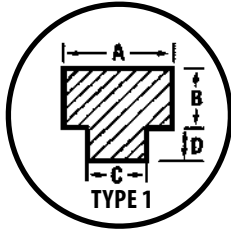

NUMÉRO	TYPE	A	B	C	D	POIDS (LBS)
198-501	1	3/16	3/32	1/8	1/16	0,088
198-502	2	3/16	3/32	1/4	3/32	0,141
198-503	2	3/16	3/33	1/4	1/8	0,166
198-504	2	1/4	1/8	5/16	1/8	0,241
198-505	2	1/4	1/8	3/8	1/8	0,269
198-506	2	1/4	1/8	3/8	3/16	0,347
198-507	1	3/8	3/16	5/16	1/8	0,375
198-508	1	3/8	3/16	5/16	5/32	0,406
198-509	2	3/8	3/16	7/16	5/32	0,475
198-510	2	3/8	3/16	1/2	3/16	0,562
198-511	2	3/8	3/16	1/2	1/4	0,68
198-512	1	1/2	1/4	7/16	5/32	0,663
198-513	2	1/2	1/4	9/16	3/16	0,788
198-514	2	1/2	1/4	5/8	3/16	0,827
198-515	2	1/2	1/4	5/8	5/16	1,09
198-516	2	1/2	1/4	11/16	1/4	1,01
198-517	1	5/8	5/16	3/8	3/16	0,906
198-518	2	5/8	5/16	11/16	1/4	1,25
198-519	1	3/4	3/8	1/2	1/4	1,39
198-520	1	3/4	3/8	5/8	3/16	1,36
198-521	1	3/4	3/8	5/8	5/16	1,64
198-522	1	3/4	3/8	11/16	1/4	1,54
198-523	2	3/4	3/8	13/16	9/32	1,74
198-524	2	3/4	3/8	7/8	7/16	2,28
198-525	2	3/4	3/8	15/16	5/16	1,97
198-526	2	3/4	3/8	1	1/2	2,66
198-527	1	1	1/2	7/8	7/16	3,02

Physical and Mechanical Properties

Tensile Strenght PSI - 75/80,000
Yield Strengt PSI - 60/70,000
Elongation in 2' - 18-25%

Reduction of Area in 2' - 50-55%
Brinell Hardness Range - 150-155
Rockwell B Hardness - 82

27-10-2023

BARRES À CLAVETTE À ENCOCHE
GIB HEAD MACHINERY KEYS



DMR GIB HEAD KEYS ARE USED FOR HOLDING PULLEYS AND GEARS TIGHTLY ON THE SHAFT. THEY ARE TAPERED 1/8' PER FOOT TO FIT SNUGLY ON THE SHAFT AND ARE MACHINED FROM 1018 STEEL

NUMÉRO	GRANDEUR	GRANDEUR	BTE
198-580	1/4 x 1	5	
198-581	1/4 x 1-1/2	5	
198-582	1/4 x 2	5	
198-583	1/4 x 2-1/2	5	
198-584	1/4 x 3	5	
198-585	1/4 x 4	5	
198-586	5/16 x 1	5	
198-587	5/16 x 1-1/2	5	
198-588	5/16 x 2	5	
198-589	5/16 x 2-1/2	5	
198-590	5/16 x 3	5	
198-591	3/8 x 1	5	
198-592	3/8 x 1-1/2	5	
198-593	3/8 x 2	5	
198-594	3/8 x 2-1/2	5	
198-595	3/8 x 3	5	
198-596	3/8 x 3-1/2	5	

NUMÉRO	GRANDEUR	GRANDEUR	BTE
198-597	3/8 x 4	5	
198-598	3/8 x 6	5	
198-599	7/16 x 4	5	
198-600	1/2 x 1	5	
198-601	1/2 x 1-1/2	5	
198-602	1/2 x 2	5	
198-603	1/2 x 2-1/2	5	
198-604	1/2 x 3	1	
198-605	1/2 x 3-1/2	1	
198-606	1/2 x 4	1	
198-607	1/2 x 6	1	
198-608	5/8 x 4	1	
198-609	5/8 x 6	1	
198-610	3/4 x 5	1	
198-611	3/4 x 6	1	
198-612	7/8 x 6	1	
198-613	1 x 6	1	



**FEUILLARD POUR CALES D'ÉPAISSEUR
SHIM STOCK**

CUIVRE / BRASS



BRASS SHIM STOCK IS USED WHERE SOME STIFFNESS IS REQUIRED AND WHERE CORROSION PROBLEMS EXIST. IT HAS BEEN COLD ROLLED TO A ½ HARD TEMPER WITH A TENSILE STRENGTH OF APPROXIMATELY 62,000 PSI. BRASS SHIM STOCK IS 70% COPPER AND 30% ZINC. IT HAS A ROCKWELL HARDNESS OF 30T 56/68. BRASS SHIM STOCK MEETS THE FOLLOWING SPECIFICATIONS : SAE-CA 260, ASTM-B-36, AMS-4507 AND QQB-613-#2. BRASS SHIM IS AVAILABLE IN THICKNESSES FROM .001»- .031» IN STANDARD PACKAGES OF 6» X 100» AND 12» X 120». TYPICAL WEIGHT: .010» X 6 X 100» 1.8 LBS.

6' X 100 ROULEAUX / ROLLS		12 X 120 ROULEAUX / ROLLS	
NUMÉRO	ÉPAISSEUR	NUMÉRO	ÉPAISSEUR
198-710	.001	198-726	.001
198-711	.0015	198-727	.002
198-712	.002	198-728	.003
198-713	.003	198-729	.004
198-714	.004	198-730	.005
198-715	.005	198-731	.006
198-716	.006	198-732	.008
198-717	.007	198-733	.010
198-718	.008		
198-719	.009		
198-720	.010		
198-721	.012		
198-722	.015		
198-723	.020		
198-724	.025		
198-725	.031		

BRASS SHIM TOLERANCES		
Decimal Thickness	6» Width	12» Width
.001 - .003.004.005 - .006	+/- 10%+/- .0003+/- .0004	+/- 10%+/- .0006+/- .0008
.007 - .009.010 - .013.014 - .017	+/- .0006+/- .0008+/- .0010	+/- .0010+/- .0013+/- .0015
.018 - .021.022 - .031	+/- .0013+/- .002	+/- .0018+/- .002
Width Tolerance	+/- .008	+/- .008



**FEUILLARD POUR CALES D'ÉPAISSEUR
SHIM STOCK**

ACIER INOXYDABLE / STAINLESS STEEL



STAINLESS STEEL SHIM CAN BE USED IN ANY APPLICATIONS WHERE CORROSION IS A CONCERN. STAINLESS STEEL IS 300 SERIES, FULL HARD TEMPER. (HALF-HARD AND ANNEALED STAINLESS IS ALSO AVAILABLE ON REQUEST.) FULL-HARD STAINLESS STEEL IS SLIGHTLY MAGNETIC DUE TO COLD ROLLING. STAINLESS STEEL SHIM STOCK HAS A ROCKWELL HARDNESS OF C40-45 AND MEETS THE FOLLOWING SPECIFICATIONS: MIL-5-5059, QQS 766 AND QQS 763. TYPICAL WEIGHT: .010» X 6» X 50» = .84#.

6 x 50 Rouleaux/ Rolls		12 x 50 Rouleaux/ Rolls	
NUMÉRO	ÉPAISSEUR	NUMÉRO	ÉPAISSEUR
198-630	.0005	198-647	.001
198-631	.001	198-648	.002
198-632	.0015	198-649	.003
198-633	.002	198-650	.004
198-634	.003	198-651	.005
198-635	.004	198-652	.006
198-636	.005	198-653	.007
198-637	.006	198-654	.008
198-638	.007	198-655	.010
198-639	.008	198-656	.012
198-640	.009	198-657	.015
198-641	.010	198-658	.020
198-642	.012	198-659	.025
198-643	.015	198-660	.031
198-644	.020		
198-645	.025		
198-646	.031		

STAINLESS STEEL SHIM TOLERANCES		
Decimal Thickness	6» Widht	12» Width
.0005 - .010.011 - .019	+/- 10%+/- .001	+/- 10%+/- .0015
.020 - .028.029 - .031	+/- .0015+/- .002	+/- .0015+/- .002
Width Tolerance	+/- .005	+/- .010

**FEUILLARD POUR CALES D'ÉPAISSEUR
SHIM STOCK**

ACIER / STEEL



STEEL SHIM STOCK IS LOW CARBON MILD STEEL COLD ROLLED TO A #1 HARD TEMPER. IT IS STIFF AND SPRINGY, AND CAN BE USED WHERE HARDNESS IS REQUIRED. THE MATERIAL CAN BE PUNCHED OR SHEARED WITH MINIMUM BURRING AND DISTORTION. STEEL SHIM STOCK MEETS THE FOLLOWING SPECIFICATIONS: AISI 1010 AND QQS 698. AVAILABLE IN .001» TO .031» AND IN STANDARD PACKAGES 6» X 100» OR 12» X 120». SPECIAL SLIT WIDTHS ARE ALSO AVAILABLE ON REQUEST. TYPICAL WEIGHT : .010» X 6» X 100» = 1.7LBS.

6» x 100» Rouleaux/ Rolls		12» x 120» Rouleaux/ Rolls	
NUMÉRO	ÉPAISSEUR	NUMÉRO	ÉPAISSEUR
198-670	.001	198-686	.001
198-671	.0015	198-687	.002
198-672	.002	198-688	.003
198-673	.003	198-689	.004
198-674	.004	198-690	.005
198-675	.005	198-691	.006
198-676	.006	198-692	.007
198-677	.007	198-693	.008
198-678	.008	198-694	.009
198-679	.009	198-695	.010
198-680	.010	198-696	.012
198-681	.012	198-697	.015
198-682	.015	198-698	.018
198-683	.020	198-699	.020
198-684	.025	198-700	.025
198-685	.031	198-701	.031

STEEL SHIM TOLERANCES		
Decimal Thickness	6» Width	12» Width
.001 - .003.0035 - .006.007 - .018	+/- 10% +/- +/- .00075	+/- 10% +/- .0005 +/- .00075
.020 - .025.031	+/- .001 +/- .0015	+/- .001 +/- .0015
Width Tolerance	+/- .005	+/- .010



1 800 463-5259
www.prdistribution.ca



Siège social

6500, rue Zéphirin-Paquet
Parc industriel Armand-Viau
Québec (Qc) Canada G2C 0M3
T : 418 872-6018 F : 418 872-6583

Inscrivez-vous à notre bulletin électronique
et suivez-nous sur Facebook !



Succursale

1100, rue Manic
Chicoutimi (Qc) Canada G7K 1A2
T : 418 545-1100 F : 418 545-1104