



Embouts

Bits

NOUS SOMMES FIERS DE VOUS PRÉSENTER NOTRE LIGNE D'EMBOUITS DE TOURNEVIS QUI SE SUBDIVISE EN PLUSIEURS CATÉGORIES DE PRODUITS.

WE ARE PROUD TO PRESENT POWER DRIVER BITS PRODUCT LINE WHICH IS SUBDIVIDED INTO SEVERAL CATEGORIES.

TITANIUM NITRIDE

AVANTAGE :

- Fabriqué en acier S2 avec un revêtement de nitrure de titane pour une durabilité élevée.
- Plus de rugosité à la prise ce qui réduit l'échappement.
- Bonne adhérence de l'acier et un revêtement qui donne aux embouts une vie extra longue.



FEATURES:

- Manufactured from S2 steel with titanium nitride coating for durability.
- Increase in roughness grips the screw and reduces cam out.
- Good bonding of steel and coating that gives the bits extra long life.

EMBOUT DIAMANTÉ DIAMOND TIPPED

AVANTAGE :

- Les grains de diamant améliorent l'engagement des vis et réduisent les risques de dommages à la prise.
- Le revêtement super dur en diamant offre une meilleure prise.
- Fabriqués en acier de haute qualité S2 trempé pour une extra longue durée.
- La zone de torsion réduit les risques de casse.
- Augmentation de la productivité globale.



FEATURES:

- The diamond grit improves screw engagement reducing the risk of damage to the screw recess.
- Super hard diamond coating wears less and grips better. The bits are manufactured of HQ toughened S2 steel that gives the bits extra long life.
- Torsion twist zone reduces bit breakage.
- Overall increased productivity.

IMPACTECH™



AVANTAGE :

- Zone de **TORSION SPIRALE** brevetée qui absorbe l'impact jusqu'à -55° résultant à une durée de vie accrue des embouts.
- Fabriqués avec le procédé exclusif d'usinage CNC*.



FEATURES:

- Patented **SPIRAL TORSION ZONE** absorbs impact resulting in longer bit life
- Precision engineered tips are manufactured with proprietary CNC* machining process

*Computerized Numerical Control

IMPACTECH™		- 55°	
Brand #2		- 42°	
Brand #3		- 30°	
Brand #4		- 20°	
Brand #5		- 19°	

(2 inch #2 Phillips Bits)

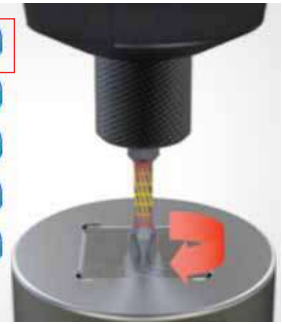









ACIER INOXIDABLE STAINLESS STEEL

AVANTAGE :

- Sans contaminants
- Idéal pour les environnements où la corrosion et la rouille sont sévères.

FEATURES:

- Contaminant free
- Ideal for environments where corrosion & rust is severe.

Embouts de tournevis CARRÉS / SQUARE Power Driver Bits		P 4-5
Embouts de tournevis PHILLIPS / PHILLIPS Power Driver Bits		P 6-7
Embouts de tournevis TORX / TORX Power Driver Bits		P 8-9
Embouts de tournevis HEX / HEX Power Driver Bits		P 10-11
Embouts de tournevis PLAT / SLOTTED Power Driver Bits		P 12
Embouts ANTIVOL / TAMPER RESISTANT Driver Bits		P 13
Cléss hexagonales / Hexagon Keys		P 14
Emboutss de soutien / Bit Holders		P 15
Ensembles / Sets		P 16



EMBOUITS RÉGULIER / REGULAR BITS



EMBOUITS EXTRA DUR / EXTRA-HARD BITS



No.	Extra Dur Extra-Hard No.	Description		Application		
				Vis à bois Wood screw	Vis Machine screw	Tapping screw
E28		#0	1"	3 & 4	3 & 4	3 & 4
E29	699-1275	#1	1"	5, 6 & 7	5 & 6	5, 6 & 7
E30	699-1279	#2	1"	8, 9 & 10	8 & 10	8 & 10
E31	699-1283	#3	1"	12 & 14	12 & 14	12 & 14
E130		R4	1"	5/16"	5/16"	5/16"

EMBOUITS RÉGULIER / REGULAR BITS



EMBOUITS EXTRA DUR / EXTRA-HARD BITS



No.	Extra Dur Extra-Hard No.	Description		Application		
				Vis à bois Wood screw	Vis Machine screw	Tapping screw
E132	699-1497	#2	2"	8, 9 & 10	8 & 10	8 & 10
	699-1501	#3	2"	12 & 14	12 & 14	12 & 14
E133		#0	1-15/16"	3 & 4	3 & 4	3 & 4
E32		#1	1-15/16"	5, 6 & 7	5 & 6	5, 6 & 7
E33		#2	1-15/16"	8, 9 & 10	8 & 10	8 & 10
E34		#3	1-15/16"	12 & 14	12 & 14	12 & 14
E134		#0	2-3/4"	3 & 4	3 & 4	3 & 4
E36	699-1602	#1	2-3/4"	5, 6 & 7	5 & 6	5, 6 & 7
E37	699-1605	#2	2-3/4"	8, 9 & 10	8 & 10	8 & 10
E38	699-1608	#3	2-3/4"	12 & 14	12 & 14	12 & 14
E42	699-1667	#1	3-1/2"	5, 6 & 7	5 & 6	5, 6 & 7
E43	699-1670	#2	3-1/2"	8, 9 & 10	8 & 10	8 & 10
E44	699-1673	#3	3-1/2"	12 & 14	12 & 14	12 & 14
E51	699-1046	#1	6"	5, 6 & 7	5 & 6	5, 6 & 7
E52	699-1049	#2	6"	8, 9 & 10	8 & 10	8 & 10
E53	699-1052	#3	6"	12 & 14	12 & 14	12 & 14

EMBOUITS 2 PARTIES / 2 PARTS BITS

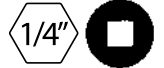

No.	Description		Application		
			Vis à bois Wood screw	Machine screw	Tapping screw
E28-2	#0	1"	3 & 4	3 & 4	3 & 4
E29-2	#1	1"	5, 6 & 7	5 & 6	5, 6 & 7
E30-2	#2	1"	8, 9 & 10	8 & 10	8 & 10
E31-2	#3	1"	12 & 14	12 & 14	12 & 14



No.	Description		Application		
			Vis à bois Wood screw	Machine screw	Tapping screw
E32-2	#1	2"	5, 6 & 7	5 & 6	5, 6 & 7
E33-2	#2	2"	8, 9 & 10	8 & 10	8 & 10
E34-2	#3	2"	12 & 14	12 & 14	12 & 14
E134-2	#0	3"	3 & 4	3 & 4	3 & 4
E39-2	#1	3"	5, 6 & 7	5 & 6	5, 6 & 7
E40-2	#2	3"	8, 9 & 10	8 & 10	8 & 10
E41-2	#3	3"	12 & 14	12 & 14	12 & 14
E142-2	#4	3-1/4"	5/16"	5/16"	5/16"
E143-2	#0	4"	3 & 4	3 & 4	3 & 4
E45-2	#1	4"	5, 6 & 7	5 & 6	5, 6 & 7
E46-2	#2	4"	8, 9 & 10	8 & 10	8 & 10
E47-2	#3	4"	12 & 14	12 & 14	12 & 14
E144-2	#0	6"	3 & 4	3 & 4	3 & 4
E51-2	#1	6"	5, 6 & 7	5 & 6	5, 6 & 7
E52-2	#2	6"	8, 9 & 10	8 & 10	8 & 10
E53-2	#3	6"	12 & 14	12 & 14	12 & 14

EMBOUITS TITANIUM NITRIDE TIPPED



No.	Description		Application		
			Vis à bois Wood screw	Vis Machine screw	Tapping screw
699-1274	#1	1"	5, 6 & 7	5 & 6	5, 6 & 7
699-1278	#2	1"	8, 9 & 10	8 & 10	8 & 10
699-1282	#3	1"	12 & 14	12 & 14	12 & 14

2 PARTIES - CODE COULEUR 2 PARTS - COLOUR-CODED					
No.	Description	Application			
		Vis à bois Wood screw	Vis Machine screw	Tapping screw	
1" LONG					
PAP140-810	#0	1"	3 & 4	3 & 4	3 & 4
PAP140-811	#1	1"	5, 6 & 7	5 & 6	5, 6 & 7
PAP140-812	#2	1"	8, 9 & 10	8 & 10	8 & 10
PAP140-813	#3	1"	12 & 14	12 & 14	12 & 14
2" LONG					
PAP140-820	#0	2"	3 & 4	3 & 4	3 & 4
PAP140-821	#1	2"	5, 6 & 7	5 & 6	5, 6 & 7
PAP140-822	#2	2"	8, 9 & 10	8 & 10	8 & 10
PAP140-823	#3	2"	12 & 14	12 & 14	12 & 14
3" LONG					
PAP140-831	#1	3"	5, 6 & 7	5 & 6	5, 6 & 7
PAP140-832	#2	3"	8, 9 & 10	8 & 10	8 & 10
PAP140-833	#3	3"	12 & 14	12 & 14	12 & 14
4" LONG					
PAP140-841	#1	4"	5, 6 & 7	5 & 6	5, 6 & 7
PAP140-842	#2	4"	8, 9 & 10	8 & 10	8 & 10
PAP140-843	#3	4"	12 & 14	12 & 14	12 & 14
6" LONG					
PAP140-871	#1	6"	5, 6 & 7	5 & 6	5, 6 & 7
PAP140-872	#2	6"	8, 9 & 10	8 & 10	8 & 10
PAP140-873	#3	6"	12 & 14	12 & 14	12 & 14
12" LONG					
PAP140-891	#1	12"	5, 6 & 7	5 & 6	5, 6 & 7
PAP140-892	#2	12"	8, 9 & 10	8 & 10	8 & 10
PAP140-893	#3	12"	12 & 14	12 & 14	12 & 14

ENS. DE 10 EMBOUTS / 10 PIECES BIT KIT					
No.	Description	Application			
		Vis à bois Wood screw	Vis Machine screw	Tapping screw	
PAP8020-982	2" Long #0, #1, #2, #3				
PAP8020-980	2" Long #1, #2, #3				

IMPACTECH™					
No.	Description	Application			
		Vis à bois Wood screw	Vis Machine screw	Tapping screw	
699-1971	#1	1"	5, 6 & 7	5 & 6	5, 6 & 7
699-1974	#2	1"	8, 9 & 10	8 & 10	8 & 10
699-1979	#3	1"	12 & 14	12 & 14	12 & 14
699-1996	#1	2"	5, 6 & 7	5 & 6	5, 6 & 7
699-2000	#2	2"	8, 9 & 10	8 & 10	8 & 10
699-2005	#3	2"	12 & 14	12 & 14	12 & 14
699-2042	#1	2-3/4"	5, 6 & 7	5 & 6	5, 6 & 7
699-2043	#2	2-3/4"	8, 9 & 10	8 & 10	8 & 10
699-2044	#3	2-3/4"	12 & 14	12 & 14	12 & 14
699-2058	#1	3-1/2"	5, 6 & 7	5 & 6	5, 6 & 7
699-2059	#2	3-1/2"	8, 9 & 10	8 & 10	8 & 10
699-2061	#3	3-1/2"	12 & 14	12 & 14	12 & 14
699-1944	#1	6"	5, 6 & 7	5 & 6	5, 6 & 7
699-1945	#2	6"	8, 9 & 10	8 & 10	8 & 10
699-1947	#3	6"	12 & 14	12 & 14	12 & 14

IMPACTECH™					
DOUBLE BOUT / DOUBLE ENDED					
No.	Description	Application			
		Vis à bois Wood screw	Vis Machine screw	Tapping screw	
699-2036	#2 + #2	2-9/16"	8, 9 & 10	8 & 10	8 & 10

EMBOUITS RÉGULIER / REGULAR BITS



EMBOUITS EXTRA DUR / EXTRA-HARD BITS



No.	Extra Dur Extra-Hard No.	Description		Application		
				Vis à bois Wood screw	Vis Machine screw	Tapping screw
E1	-	#0	1"	0, 1	0, 1	0, 1
E2	699-1248	#1	1"	1, 2, 3, 4	1, 2, 3, 4	1, 2, 3, 4
E3	699-1250	#2	1"	5, 6, 7, 8, 9, 10	5, 6, 8, 10	5, 6, 7, 8, 10
E4	699-1260	#3	1"	12, 14, 16	12, 14	12, 14
E115	-	#4	1"	3/8"	3/8"	3/8"
E5	-	#1R	1"	1, 2, 3, 4	1, 2, 3, 4	1, 2, 3, 4
E6	-	#2R	1"	5, 6, 7, 8, 9, 10	5, 6, 8, 10	5, 6, 7, 8, 10

EMBOUITS RÉGULIER / REGULAR BITS



EMBOUITS EXTRA DUR / EXTRA-HARD BITS



No.	Extra Dur Extra-Hard	Description		Application		
				Vis à bois Wood screw	Vis Machine screw	Tapping screw
E117	-	#2	1-1/2"	5, 6, 7, 8, 9, 10	5, 6, 8, 10	5, 6, 7, 8, 10
E118	699-1473	#2	2"	5, 6, 7, 8, 9, 10	5, 6, 8, 10	5, 6, 7, 8, 10
E119	699-1485	#3	2"	12, 14, 16	12, 14	12, 14
E120	-	#0	1-15/16"	0, 1	0, 1	0, 1
E7	-	#1	1-15/16"	1, 2, 3, 4	1, 2, 3, 4	1, 2, 3, 4
E8	-	#2	1-15/16"	5, 6, 7, 8, 9, 10	5, 6, 8, 10	5, 6, 7, 8, 10
E9	-	#3	1-15/16"	12, 14, 16	12, 14	12, 14
E10	-	#0	2-3/4"	1, 2, 3, 4	1, 2, 3, 4	1, 2, 3, 4
E11	699-1588	#1	2-3/4"	5, 6, 7, 8, 9, 10	5, 6, 8, 10	5, 6, 7, 8, 10
E12	699-1591	#2	2-3/4"	12, 14, 16	12, 14	12, 14
E16	699-1656	#1	3-1/2"	1, 2, 3, 4	1, 2, 3, 4	1, 2, 3, 4
E17	699-1659	#2	3-1/2"	5, 6, 7, 8, 9, 10	5, 6, 8, 10	5, 6, 7, 8, 10
E18	699-1664	#3	3-1/2"	12, 14, 16	12, 14	12, 14
E25	699-1035	#1	6"	1, 2, 3, 4	1, 2, 3, 4	1, 2, 3, 4
E26	699-1038	#2	6"	5, 6, 7, 8, 9, 10	5, 6, 8, 10	5, 6, 7, 8, 10
E27	699-1043	#3	6"	12, 14, 16	12, 14	12, 14

ACIER INOXIDABLE / STAINLESS STEEL



No.	Description		Application		
			Vis à bois Wood screw	Vis Machine screw	Tapping screw
699-1247	#1	1"	5, 6 & 7	5 & 6	5, 6 & 7
699-1259	#2	1"	8, 9 & 10	8 & 10	8 & 10
699-1266	#3	1"	12 & 14	12 & 14	12 & 14

EMBOUITS TITANIUM NITRIDE TIPPED



No.	Description		Application		
			Vis à bois Wood screw	Vis Machine screw	Tapping screw
699-1241	#1	1"	5, 6 & 7	5 & 6	5, 6 & 7
699-1249	#2	1"	8, 9 & 10	8 & 10	8 & 10
699-1261	#3	1"	12 & 14	12 & 14	12 & 14

EMBOUITS DIAMANTÉ / DIAMOND TIPPED















No.	Description		Application		
			Vis à bois Wood screw	Vis Machine screw	Tapping screw
699-1243	#1	1"	5, 6 & 7	5 & 6	5, 6 & 7
699-1253	#2	1"	8, 9 & 10	8 & 10	8 & 10
699-1263	#3	1"	12 & 14	12 & 14	12 & 14



TYPE ACR / ACR TYPE

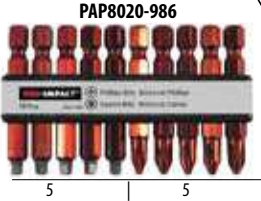



No.	Description		Application		
			Vis à bois Wood screw	Vis Machine screw	Tapping screw
E54	#1	1"	1, 2, 3, 4	1, 2, 3, 4	1, 2, 3, 4
E55	#2	1"	5, 6, 7, 8, 9, 10	5, 6, 8, 10	5, 6, 7, 8, 10
E56	#3	1"	12, 14, 16	12, 14	12, 14
E121*	#2	1"	5, 6, 7, 8, 9, 10	5, 6, 8, 10	5, 6, 7, 8, 10
E57	#1	1-15/16"	1, 2, 3, 4	1, 2, 3, 4	1, 2, 3, 4
E58	#2	1-15/16"	5, 6, 7, 8, 9, 10	5, 6, 8, 10	5, 6, 7, 8, 10
E59	#3	1-15/16"	12, 14, 16	12, 14	12, 14

CODE COULEUR / COLOUR-CODED 					
No.	Description	Application			
		Vis à bois Wood screw	Vis Machine screw	Tapping screw	
1" LONG 					
PAP140-911	#1 1"	5, 6 & 7	5 & 6	5, 6 & 7	
PAP140-912	#2 1"	8, 9 & 10	8 & 10	8 & 10	
PAP140-913	#3 1"	12 & 14	12 & 14	12 & 14	
2" LONG 					
PAP140-921	#1 2"	5, 6 & 7	5 & 6	5, 6 & 7	
PAP140-924	#2 2"	8, 9 & 10	8 & 10	8 & 10	
PAP140-923	#3 2"	12 & 14	12 & 14	12 & 14	
3" LONG 					
PAP140-931	#1 3"	5, 6 & 7	5 & 6	5, 6 & 7	
PAP140-932	#2 3"	8, 9 & 10	8 & 10	8 & 10	
PAP140-933	#3 3"	12 & 14	12 & 14	12 & 14	
4" LONG 					
PAP140-941	#1 4"	5, 6 & 7	5 & 6	5, 6 & 7	
PAP140-942	#2 4"	8, 9 & 10	8 & 10	8 & 10	
PAP140-943	#3 4"	12 & 14	12 & 14	12 & 14	
6" LONG 					
PAP140-971	#1 6"	5, 6 & 7	5 & 6	5, 6 & 7	
PAP140-972	#2 6"	8, 9 & 10	8 & 10	8 & 10	
PAP140-973	#3 6"	12 & 14	12 & 14	12 & 14	
12" LONG 					
PAP140-991	#1 12"	5, 6 & 7	5 & 6	5, 6 & 7	
PAP140-992	#2 12"	8, 9 & 10	8 & 10	8 & 10	
PAP140-993	#3 12"	12 & 14	12 & 14	12 & 14	

ENS. DE 10 EMBOUTS / 10 PIECES BIT KIT 	
	
No.	Description
PAP8020-984	2" Long #1, #2, #3 
PAP8020-986	2" Long #1, #2, #3  

IMPACTECH ™ 					
No.	Description	Application			
		Vis à bois Wood screw	Vis Machine screw	Tapping screw	
					
699-1959	#1 1"	5, 6 & 7	5 & 6	5, 6 & 7	
699-1962	#2 1"	8, 9 & 10	8 & 10	8 & 10	
699-1967	#3 1"	12 & 14	12 & 14	12 & 14	
					
699-1989	#1 2"	5, 6 & 7	5 & 6	5, 6 & 7	
699-1991	#2 2"	8, 9 & 10	8 & 10	8 & 10	
699-1996	#3 2"	12 & 14	12 & 14	12 & 14	
699-2039	#1 2-3/4"	5, 6 & 7	5 & 6	5, 6 & 7	
699-2040	#2 2-3/4"	8, 9 & 10	8 & 10	8 & 10	
699-2041	#3 2-3/4"	12 & 14	12 & 14	12 & 14	
699-2052	#1 3-1/2"	5, 6 & 7	5 & 6	5, 6 & 7	
699-2053	#2 3-1/2"	8, 9 & 10	8 & 10	8 & 10	
699-2056	#3 3-1/2"	12 & 14	12 & 14	12 & 14	
699-1940	#1 6"	5, 6 & 7	5 & 6	5, 6 & 7	
699-1941	#2 6"	8, 9 & 10	8 & 10	8 & 10	
699-1943	#3 6"	12 & 14	12 & 14	12 & 14	

IMPACTECH ™					
DOUBLE BOUT / DOUBLE ENDED 					
No.	Description	Application			
		Vis à bois Wood screw	Vis Machine screw	Tapping screw	
					
699-2033	#2 + #2 2-9/16"	8, 9 & 10	8 & 10	8 & 10	

19-06-2024

EMBOUS RÉGULIER / REGULAR BITS					
 1/4" 					
No.	Description		Application		
	# Ref	Pouces Inchs	Flat head cap screw	Tapping screw	
				Pouce / Inch	Metric
E160	#3	1"			
E161	#4	1"			
E162	#5	1"			
E61	#6	1"			
E62	#7	1"			
E63	#8	1"			
E64	#9	1"	4	4	
E65	#10	1"	5	4, 5	2,9
E66	#15	1"	6	6, 8	3,5, 3,9, 4,2
E67	#20	1"	8	8, 10	4,8
E68	#25	1"	10	10	
E69	#27	1"	12		
E70	#30	1"	1/4"	1/4"	5,5, 6,3
E71	#40	1"	5/16"	5/16"	7,0, 8,0

EMBOUS RÉGULIER / REGULAR BITS					
 1/4" 					
No.	Description		Application		
	# Ref	Pouces Inchs	Flat head cap screw	Tapping screw	
				Pouce / Inch	Metric
E163	#5	1-15/16"			
E164	#6	1-15/16"			
E165	#7	1-15/16"			
E88	#8	1-15/16"			
E89	#9	1-15/16"	4	4	
E90	#10	1-15/16"	5	4, 5	2,9
E91	#15	1-15/16"	6	6, 8	3,5, 3,9, 4,2
E92	#20	1-15/16"	8	8, 10	4,8
E93	#25	1-15/16"	10	10	
E94	#27	1-15/16"	12		
E95	#30	1-15/16"	1/4"	1/4"	5,5, 6,3
E96	#40	1-15/16"	5/16"	5/16"	7,0, 8,0
E171	#10	2-3/4"	5	4, 5	2,9
E172	#15	2-3/4"	6	6, 8	3,5, 3,9, 4,2
E173	#20	2-3/4"	8	8, 10	4,8
E174	#25	2-3/4"	10	10	
E175	#27		12		
E176	#30		1/4"	1/4"	5,5, 6,3
E177	#40		5/16"	5/16"	7,0, 8,0
E182	#10		5	4, 5	2,9
E183	#15		6	6, 8	3,5, 3,9, 4,2
E184	#20		8	8, 10	4,8
E185	#25		10	10	
E186	#27		12		
E187	#30		1/4"	1/4"	5,5, 6,3
E188	#40		5/16"	5/16"	7,0, 8,0



RÉGULIER 5/16" / REGULAR 5/16"					
 5/16" 					
No.	Description		Application		
	# Ref	Pouces Inchs	Flat head cap screw	Tapping screw	
				Pouce / Inch	Metric
ST27	#27	1-1/4"			
E190	#30	1-1/4"	1/4"	1/4"	5,5, 6,3
E191	#40	1-1/4"	5/16"	5/16"	7,0, 8,0
E192	#45	1-1/4"	3/8"	3/8"	
E193	#50	1-1/4"	7/16", 1/2"	7/16"	10
E194	#55	1-1/4"	5/8"		
E195	#60	1-1/4"	3/4"		

ACIER INOXIDABLE / STAINLESS STEEL 





No.	Description		Application		
			Vis à bois Wood screw	Vis Machine screw	Tapping screw
699-1301	#10	1"	5	4, 5	2,9
699-1304	#15	1"	6	6, 8	3,5, 3,9, 4,2
699-1309	#25	1"	10	10	
699-1312	#27	1"	12		
699-1315	#30	1"	1/4"	1/4"	5,5, 6,3
699-1318	#40	1"	5/16"	5/16"	7,0, 8,0

EMBOUT DIAMANTÉ / DIAMOND TIPPED 





No.	Description		Application		
			Vis à bois Wood screw	Vis Machine screw	Tapping screw
699-1296	#8	1"			
699-1300	#10	1"	5	4, 5	2,9
699-1303	#15	1"	6	6, 8	3,5, 3,9, 4,2
699-1306	#20	1"	8	8, 10	4,8
699-1308	#25	1"	10	10	
699-1311	#27	1"	12		
699-1314	#30	1"	1/4"	1/4"	5,5, 6,3
699-1317	#40	1"	5/16"	5/16"	7,0, 8,0



IMPACTTECH™ 



No.	Description		Application		
			Vis à bois Wood screw	Vis Machine screw	Tapping screw
699-1981	#10	1"	5	4, 5	2,9
699-1982	#15	1"	6	6, 8	3,5, 3,9, 4,2
699-1983	#20	1"	8	8, 10	4,8
699-1984	#25	1"	10	10	
699-1986	#27	1"	12		
699-1987	#30	1"	1/4"	1/4"	5,5, 6,3
699-1988	#40	1"	5/16"	5/16"	7,0, 8,0



No.	Description		Application		
			Vis à bois Wood screw	Vis Machine screw	Tapping screw
699-2007	#10	2"	5	4, 5	2,9
699-2009	#15	2"	6	6, 8	3,5, 3,9, 4,2
699-2011	#20	2"	8	8, 10	4,8
699-2014	#25	2"	10	10	
699-2018	#27	2"	12		
699-2020	#30	2"	1/4"	1/4"	5,5, 6,3
699-2022	#40	2"	5/16"	5/16"	7,0, 8,0

EMBOUS RÉGULIER / REGULAR BITS		
		
		
No.	Description	
	Pointe Point size	Pouces Inchs
699-1179	1/16"	1"
699-1181	5/64"	1"
699-1183	3/32"	1"
699-1186	7/64"	1"
699-1189	1/8"	1"
699-1191	9/64"	1"
699-1193	5/32"	1"
699-1195	3/16"	1"
699-1197	7/32"	1"
699-1199	1/4"	1"
699-1201	5/16"	1"

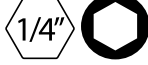
EMBOUS RÉGULIER / REGULAR BITS		
		
		
MÉTRIQUE / METRIC		
No.	Description	
	Pointe Point size	Pouces Inchs
699-1174	1.5 mm	1"
699-1175	2 mm	1"
699-1176	2.5 mm	1"
699-1177	3 mm	1"
699-1178	4 mm	1"
699-1180	5 mm	1"
699-1182	6 mm	1"
699-1185	7 mm	1"
699-1188	8 mm	1"

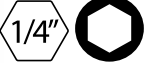
EMBOUS RÉGULIER / REGULAR BITS		
		
		
No.	Description	
	Pointe Point size	Pouces Inchs
699-1448	1/16"	2"
699-1450	5/64"	2"
699-1452	3/32"	2"
699-1453	7/64"	2"
699-1454	1/8"	2"
699-1455	9/64"	2"
699-1456	5/32"	2"
699-1457	3/16"	2"
699-1458	7/32"	2"
699-1459	1/4"	2"
699-1460	5/16"	2"

GUIDE DE CLÉ POUR VIS À SIX PANS CREUX

SOCKET HEAD SIZING GUIDE

SAE	Socket Head 1960 Series	Socket Head 1960 Series	Flat Head Cap Screws	Button Head Cap Screws	Set Screws	Shoulder Screws	Pressure Plugs	Allenuts	Low Head Cap Screws
Nominal Hex Size, Inches									
0.050	0	0,1	1, 2	3,4	-	-	-	4	.050
1/16	1	2	3, 4	3,4	5,6	-	-	-	5,6
5/64	2,3	3,4	5, 6	5,6	8	-	-	-	8
3/32	4,5	5,6	8	8	10	-	-	-	10
7/64	6	-	-	-	-	-	-	-	-
1/8	-	8	10	10	1/4	1/4	-	4,5	1/4
9/64	8	10	-	-	-	-	-	-	-
5/32	10	1/4	1/4	1/4	5/16	5/16	1/16	6	5/16
3/16	1/4	-	5/16	5/16	3/8	3/8	1/8	8,10	3/8
7/32	-	5/16	3/8	3/8	7/16	-	-	-	7/16
1/4	5/16	-	7/16	-	1/2	1/2	1/4	1/4	1/2
5/16	3/8	3/8,7/16	1/2	-	5/8	5/8	3/8	5/16	5/8
3/8	7/16,1/2	1/2	5/8	-	3/4	3/4	1/2	3/8	-
7/16	-	-	-	-	-	-	-	7/16	-
1/2	5/8	5/8	3/4	-	7/8	1	-	1/2	-
9/16	-	3/4,7/8	7/8	-	1,1 1/8	-	3/4	-	-
5/8	3/4	1	1	-	1 1/4,1 3/8	1 1/4	1	5/8	-
3/4	7/8,1	1 1/8,1 1/4,1 3/8	1 1/8	-	1 1/2	-	1 1/4	3/4	-
7/8	1 1/8,1 1/4	-	1 1/4, 1 3/8	-	-	1 1/2	-	7/8	-
1	1 3/8,1 1/2	1 1/2	1 1/2	-	1 3/4,2	1 3/4	1 1/2,2	1	-
1 1/4	1 3/4	-	-	-	-	2	-	1 1/4	-
1 1/2	2	-	-	-	-	-	-	1 1/2	-
1 3/4	2 1/4,2 1/2	-	-	-	-	-	-	-	1 3/4
2	2 3/4	-	-	-	-	-	-	-	-

Metric	Socket Head Cap Screws	Flat Head Cap Screws	Button Head Cap Screws	Set Screws	Shoulder Screws	Allenuts	Low Head Cap Screws
Nominal Hex Size, (MM)							
1.5	M1.6 M1.7 M2	-	-	M3	-	-	-
2	M2.3 M2.5 M2.6	M3	M3	M4	-	-	-
2.5	M3	M4	M4	M5	-	-	-
3	M4	M5	M5	M6	6mm	M3	M4
4	M5	M6	M6	M8	8mm	M4	M5
5	M6	M8	M8	M10	10mm	M5	M6
6	M8	M10	M10	M12,M14	12mm	M6	M8
8	M10	M12	M12	M16	16mm	M8	M10
10	M12	M14,M16	-	M18	20mm	M10	M12
12	M14	M20	-	M20	-	M12	M14
14	M16	-	-	-	-	-	M16
17	M20	-	-	-	-	M16	M20,M22
19	M24	-	-	-	-	-	M24

19-06-2024

EMBOUS RÉGULIER / REGULAR BITS



No.	Description	
	Pointe Point size	Pouces Inchs
699-1150	.026 X .125	1"
699-1151	.028 X .104	1"
699-1152	.032 X .156	1"
699-1156	.034 X .187	1"
699-1160	.036 X .218	1"
699-1164	.040 X .250	1"
699-1168	.046 X .281	1"
699-1172	.052 X .355	1"
699-1173	.056 X .355	1"

EMBOUT TITANIUM NITRIDE TIPPED



No.	Description	
	Pointe Point size	Pouces Inchs
699-1153	.032 X .156	1"
699-1157	.034 X .187	1"
699-1161	.036 X .218	1"
699-1165	.040 X .250	1"
699-1169	.046 X .281	1"

ACIER INOXIDABLE / STAINLESS STEEL



No.	Description	
	Pointe Point size	Pouces Inchs
699-1155	.032 X .156	1"
699-1159	.034 X .187	1"
699-1163	.036 X .218	1"
699-1167	.040 X .250	1"
699-1171	.046 X .281	1"

IMPACTTECH™

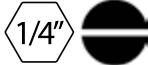

No.	Description	
	Pointe Point size	Pouces Inchs
699-1948	4-5	1"
699-1949	6-8	1"
699-1950	8-10	1"

EMBOUT DIAMANTÉ / DIAMOND TIPPED



No.	Description	
	Pointe Point size	Pouces Inchs
699-1154	.032 X .156	1"
699-1158	.034 X .187	1"
699-1162	.036 X .218	1"
699-1166	.040 X .250	1"
699-1170	.046 X .281	1"



ANTI-VOL TORX / TORX TAMPER PROOF 1/4" 



No.	Description	
	Pointe/ Point size	Pouces / Inchs
699-1341	5	1"
699-1342	6	1"
699-1343	7	1"
699-1344	8	1"
699-1345	9	1"
699-1346	10	1"
699-1347	15	1"
699-1348	20	1"
699-1349	25	1"
699-1350	27	1"
699-1351	30	1"
699-1352	40	1"
699-1353	45	1"

ANTI-VOL SPANNER TAMPER PROOF 1/4" 



No.	Description	
	Pointe/ Point size	Pouces / Inchs
699-1286	4	1"
699-1287	6	1"
699-1288	8	1"
699-1289	10	1"
699-1290	12	1"
699-1291	14	1"



CLÉS HEXAGONALES EN ACIER - TYPE L

L - TYPE HEXAGON KEYS



IMPÉRIALE / IMPERIAL

HEXAGON DIMENSION MAX	No. SERIE COURTE SHORT SERIES	No. SERIE LONGUE LONG SERIES	LONGUEUR BRAS LONG LENGTH OF LONG ARM		LONGUEUR BRAS COURT LENGTH OF SHORT ARM	BTE BOX
			COURTE SHORT	LONGUE LONG		
.028	149-935	---	1.219	2.594	.219	100
.035	149-936	---	1.219	2.672	.344	100
.050	149-937	149-937L	1.656	2.844	.531	100
1/16	149-938	149-938L	1.750	3.000	.562	100
5/64	149-910	149-910L	1.875	3.188	.609	100
3/32	149-911	149-911L	2.000	3.375	.656	100
7/64	149-912	149-912L	2.125	3.562	.703	100
1/8	149-913	149-913L	2.250	3.750	.750	100
9/64	149-916	149-916L	2.375	3.937	.796	100
5/32	149-917	149-917L	2.500	4.125	.844	100
3/16	149-918	149-918L	2.750	4.500	.938	100
7/32	149-918A	149-918AL	3.000	4.875	1.031	50
1/4	149-919	149-919L	3.250	5.250	1.125	50
5/16	149-921	149-921L	3.750	6.000	1.250	50
3/8	149-922	149-922L	4.250	6.750	1.375	25
7/16	149-923	149-923L	4.750	7.500	1.500	25
1/2	149-924	149-924L	5.250	8.250	1.625	25
9/16	149-925	149-925L	5.750	9.000	1.750	25
5/8	149-926	149-926L	6.250	9.750	1.875	10
3/4	149-927	149-927L	7.250	11.250	2.125	10
7/8	149-928	149-928L	8.250	12.750	2.375	10
1	149-929	149-929L	9.250	14.250	2.625	10
1-1/4	149-931	---	11.250	---	3.000	1
1-1/2	149-933	---	13.250	---	3.500	1
1-3/4	149-934	---	14.25	---	4.000	1

ENSEMBLE DE 9 CLÉS HEX. EN ACIER - BRAS COURT

9 SHORT ARMS HEXAGON KEYS KIT

Comprends / Contains:
5/64, 3/32, 7/64, 1/8, 9/64,
5/32, 3/16, 7/32, 1/4

No. 5368



CLÉS HEXAGONALES EN ACIER - TYPE L

L - TYPE HEXAGON KEYS



MÉTRIQUE / METRIC

HEXAGON DIMENSION MAX	No. SERIE COURTE SHORT SERIES	No. SERIE LONGUE LONG SERIES	LONGUEUR BRAS LONG LENGTH OF LONG ARM				LONGUEUR BRAS COURT LENGTH OF SHORT ARM MAX / MIN	BTE BOX
			COURTE SHORT		LONGUE LONG			
0.7 mm	149-976	---	34	28			8 3	100
0.9 mm	149-977	---	34	28	71	65	11 6	100
1.3 mm	149-978	---	44	39	75	69	12 11	100
1.5 mm	149-979	149-979L	45	43	78	76	14 13	100
2 mm	149-980	149-980L	50	48	83	81	16 15	100
2.5 mm	149-965	149-965L	56	53	90	87	18 17	100
3 mm	149-966	149-966L	63	60	100	97	20 18	100
4 mm	149-967	149-967L	70	66	106	102	25 23	100
5 mm	149-968	149-968L	80	76	118	114	28 26	100
6 mm	149-969	149-969L	90	86	140	136	32 30	50
8 mm	149-970	149-970L	100	95	160	165	36 34	50
10 mm	149-971	149-971L	112	106	170	164	40 38	25
12 mm	149-972	149-972L	125	119	212	206	45 43	25
14 mm	149-973	149-973L	140				56 53	25
17 mm	149-974	149-974L	160	152	250	242	63 60	10
19 mm	149-975	149-975L	180	171	280	271	70 67	10

CLÉS HEXAGONALES EN ACIER - EN T

T - TYPE HEXAGON KEYS



IMPÉRIALE / IMPERIAL

MÉTRIQUE / METRIC

HEXAGONE DIMENSION	No.	BTE BOX	HEXAGONE DIMENSION	No.	BTE BOX
3/32	5341	10	2mm	5351	5
7/64	5342	10	2.5mm	5352	5
1/8	5343	10	3mm	5353	5
9/64	5344	10	4mm	5354	5
5/32	5345	10	5mm	5355	5
3/16	5346	10	6mm	5356	5
7/32	5347	5	8mm	5357	5
1/4	5348	5	10mm	5358	5
5/16	5349	5			
3/8	5350	5			

MAGNÉTIQUE / MAGNETIC 1/4"



No.	HEX	Longueur / Length
E81	3/16"	1-3/4"
E82	1/4"	1-3/4"
E83	5/16"	1-3/4"
E84	3/8"	1-3/4"
E85	7/16"	1-3/4"
E86	1/2"	1-3/4"
E200	6mm	1-3/4"
E201	7mm	1-3/4"
E202	8mm	1-3/4"
E203	10mm	1-3/4"
E204	3/16"	2-9/16"
E77	1/4"	2-9/16"
E78	5/16"	2-9/16"
E79	3/8"	2-9/16"
E80	7/16"	2-9/16"
E205	1/2"	2-9/16"
E206	6mm	2-9/16"
E207	7mm	2-9/16"
E208	8mm	2-9/16"
E209	10mm	2-9/16"

ACIER INOXYDABLE MAGNÉTIQUE 1/4"
STAINLESS STEEL MAGNETIC 1/4"



Numéro	HEX	LONGEUR - LENGHT
E100	1/4"	3"
E101	1/4"	4"
E102	1/4"	6"
E103	1/4"	8"
E104	1/4"	10"
E105	1/4"	12"

IMPACTECH™

ADAPTATEUR MAGNÉTIQUE / MAGNETIC ADAPTER 1/4"



No.	Longueur Length	Description
699-2045	3"	MAGNÉTIQUE / MAGNETIC
699-1938	6"	MAGNÉTIQUE / MAGNETIC

ADAPTATEUR DÉBLOCAGE RAPIDE - MAGNÉTIQUE
QUICK RELEASE ADAPTER - MAGNETIC 1/4"



No.	Longueur Length	Description
699-2048	3"	Déblocage rapide - MAGNÉTIQUE Quick Release - MAGNETIC

ADAPTATEUR DÉBLOCAGE RAPIDE
QUICK RELEASE ADAPTER 1/4"



No.	Longueur Length	Description
699-2051	3"	Adaptateur débloccage rapide Quick Release Adapter

VISSEUSE MAGNÉTIQUE
MAGNETIC NUTSETTER 1/4"



No.	Taille de point Point Size	Longueur Length
699-2023	1/4	2- 9/16"
699-2025	5/16	2- 9/16"
699-2027	3/8	2- 9/16"
699-2029	7/16	2- 9/16"
699-2031	1/2	2- 9/16"

IMPACTECH™

ENSEMBLE DE 19 EMBOUTS
19 PC IMPACTECH DRIVER BIT SET





No.	Comprend / Contains
699-2062	19 Pièces

IMPACTECH™

ENSEMBLE DE 21 EMBOUTS
21 PC IMPACTECH DRIVER BIT SET





No.	Comprend / Contains
699-2063	21 Pièces

IMPACTECH™

ENSEMBLE DE 34 EMBOUTS
34 PC IMPACTECH DRIVER BIT SET





No.	Comprend / Contains
699-2064	34 Pièces / 34 Pcs

19 PIÈCES / PCS COMPRED / CONTAIN		21 PIÈCES / PCS COMPRED / CONTAINS		34 PIÈCES / PCS COMPRED / CONTAINS	
Description	Qty	Description	Qty	Description	Qty
Phillips #2 X 1"	8	Phillips #1 X 1"	1	Phillips #1 X 1"	1
Square #1 X 1"	1	Phillips #2 X 1"	1	Phillips #2 X 1"	1
Square #2 X 1"	1	Phillips #3 X 1"	1	Phillips #3 X 1"	1
Square #3 X 1"	1	Square #1 X 1"	1	Square #1 X 1"	1
Phillips #2 X 2"	8	Square #2 X 1"	1	Square #2 X 1"	1
Phillips #3 X 2"	8	Square #3 X 1"	1	Square #3 X 1"	1
Square #2 X 2"	1	Torx 20 X 2"	1	Hex 5/32" X 1"	1
Mag. Bit Holder	1	Torx 25 X 1"	1	Hex 6/16" X 1"	1
1/4" Mag. Nutsetter	1	Torx 24 X 1"	1	Hex 7/32" X 1"	1
5/16" Mag. Nutsetter	1	Torx 30 X 1"	1	Hex 1/4" X 1"	1
		Phillips #1 X 2"	1	Slotted 4-5 X 1"	1
		Phillips #2 X 2"	1	Slotted 6-8 X 1"	1
		Square #1 X 2"	1	Slotted 8-10 X 1"	1
		Square #2 X 2"	1	Torx 20 X 2"	1
		Phillips #2 X 6"	1	Torx 25 X 1"	1
		Square #2 X 6"	1	Torx 27 X 1"	1
		Mag. Bit Holder	1	Torx 30 X 1"	1
		1/4" Mag. Nutsetter	1	Phillips #1 X 2"	1
		5/16" Mag. Nutsetter	1	Phillips #2 X 2"	1
		3/8" Mag. Nutsetter	1	Phillips #3 X 2"	1
		7/16" Mag. Nutsetter	1	Square #2 X 2"	1
				Mag. Bit Holder	1

**CONTACTEZ-NOUS
GET IN TOUCH**

1 800 463-5259

info@prdistribution.ca

**Notre service,
toujours en tête.^{MD}**

**Our service,
one step ahead.TM**

prdistribution.ca

1 800 463-5259
info@prdistribution.ca

Siège social • Head Office

6500, rue Zéphirin-Paquet
Québec QC G2C 0M3
T 418 872-6018 F 418 872-6583

Succursale • Branch

1100, rue de la Manic
Saguenay QC G7K 1A2
T 418 545-1100 F 418 545-1104

